

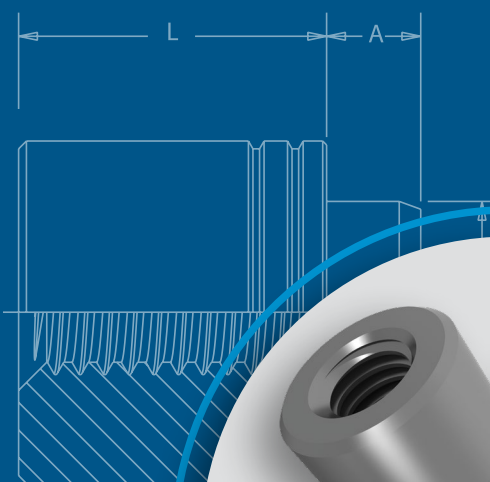

KTM

FASTENERS FOR USE WITH PC BOARDS

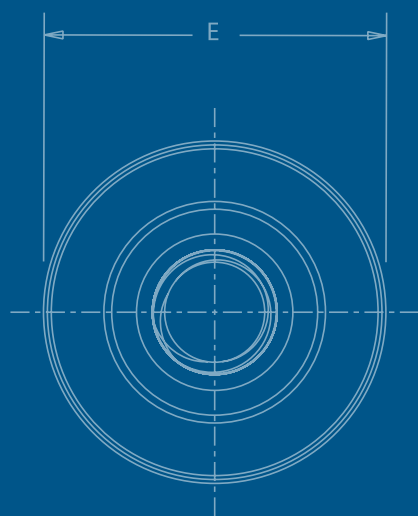

PEM[®] brand fasteners that utilize, surface-mount, broaching and flaring technology for use with PC boards.

No matter how sophisticated or advanced, electronic components must be attached reliably and securely if they are to deliver optimum performance. We offer several fastener products for use with PC boards to satisfy component-to-board, board-to-board, and board-to-chassis attachment needs.

ReelFast® surface mount fasteners mount on PC boards in the same manner and at the same time as other surface mount components prior to the automated reflow solder process. The fasteners simply become another board component. This alleviates concerns about potential damage to PC boards due to improper secondary installation operations. The fasteners are provided on tape and reel compatible with existing SMT automated installation equipment. The benefits of using ReelFast® SMT fasteners are: faster assembly; reduced scrap; reduced handling; and reduced risk of board damage.

Broaching fasteners can also offer practical alternatives to “loose” hardware. A broaching fastener is a knurled-shank fastening device that can be pressed into a hole to provide a permanent, strong, threaded or unthreaded attachment point in PC boards. They can also be used in aluminum, acrylic, casting and polycarbonate components. Specially formed axial grooves around the shank of the fastener “broach” or cut into the material, creating a firm, interference-type fit resistant to rotation. In PC boards, broaching fasteners are recommended for use in non-plated holes.

Broach/flare-mount standoffs (KFB3™) offer a combined broach/flare feature for even greater pullout performance in PC board materials.

Fastener drawings and models are available at www.pemnet.com. Custom sizes are available on special order. [Contact us](#) for more information.

Nuts And Spacers/Standoffs

SMTBSO™ - ReelFast® surface mount fasteners with internal blind-hole threads - [PAGE 4](#)



SMTSO™/SMTSOB™ — ReelFast® surface mount nuts and standoffs are available threaded and unthreaded — [PAGE 5](#)



SMTSS™ — ReelFast® SNAP-TOP® standoffs feature a spring action to hold PC board securely without screws or threaded hardware — [PAGE 6](#)



SMTSK™ — ReelFast® KEYHOLE® standoffs eliminate the need for attaching screws — [PAGE 7](#)



KFE™/KFSE™ — Broaching standoffs, threaded or unthreaded for stacking or spacing — [PAGE 8](#)



KF2™/KFS2™ — Broaching nuts, internally threaded for mounting on PC boards — [PAGE 9](#)



KFB3™ — Broach/flare-mount standoffs with greater pullout performance — [PAGE 10](#)



KSSB™ — Broaching, SNAP-TOP® standoffs feature a spring action to hold PC board securely without screws or threaded hardware — [PAGE 11](#)



Captive Panel Screws

SMTPFSLM™ — ReelFast® surface mount spring-loaded captive panel screws — [PAGE 12](#)



SMTPF™ — ReelFast® surface mount captive panel screws — [PAGE 13](#)



PFK™ - Broaching panel fastener assemblies for mounting on PC boards — [PAGE 14](#)



Studs

KFH™ — Threaded broaching studs for use as solderable connectors or as permanently mounted studs on PC boards — [PAGE 15](#)



Right Angle Fasteners

SMTRA™ — ReelFast® R'ANGLE® surface mount fasteners provide strong re-usable threads at right angles to PC boards — [PAGE 16](#)



Sheet Joining Fasteners

SFK™ — SpotFast® clinch/broach mount fasteners for joining metal to PCB/plastic panels — [PAGE 17](#)



Material and Finish Specifications

— [PAGE 18](#)

Installation

— [PAGE 18-20](#)

Performance Data

— [PAGE 21-23](#)

Other fasteners for use with PC boards

— [PAGE 24](#)

Quick Reference Chart

PEM® Fastener	Page No.	Mounting Types				Primary Use							
		Broach	Broach/ Flare	Surface Mount	Clinch/ Broach	Nut	Spacer/ Standoff	Snap Attachment	Stud	Captive Screw	Color Coding	Right Angle Attachment	Sheet to Sheet Joining
SMTBSO	4			▪		▪	▪						
SMTSO/SMTSOB	5			▪		▪	▪						
SMTSS	6			▪			▪	▪					
SMTSK	7			▪			▪						
KFE/KFSE	8	▪					▪						
KF2/KFS2	9	▪				▪							
KFB3	10		▪				▪						
KSSB	11	▪					▪	▪					
SMTPLSM	12			▪						▪			
SMTPF	13			▪						▪	▪		
PFK	14	▪								▪			
KFH	15	▪							▪				
SMTRA	16			▪								▪	
SFK	17				▪								▪

PEM® Trademarks

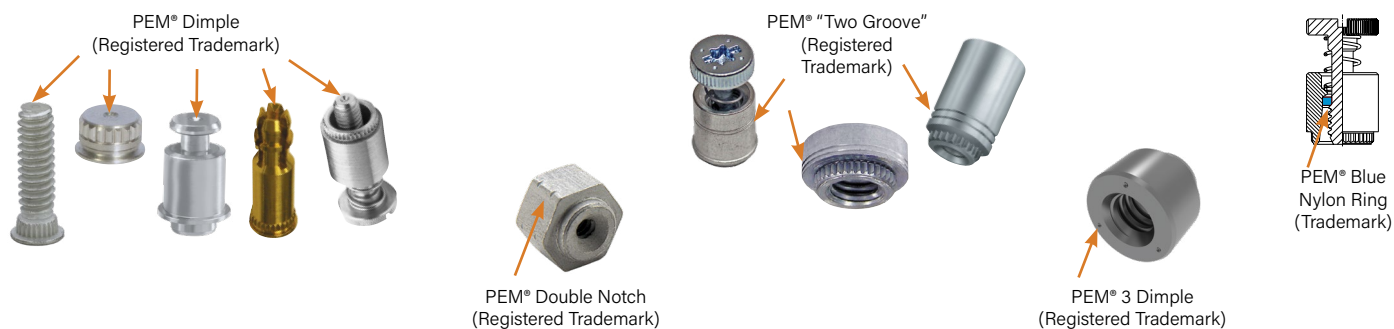

To be sure that you are getting genuine PEM® brand fasteners, look for the unique PEM® product markings and identifiers.



Fastener drawings and models are available at www.pemnet.com

Custom sizes are available on special order. [Contact us](#) for more information.

SMTBSO™ ReelFast® Surface Mount Fasteners

- Internal blind-hole threads securely mounts onto PC Board - less risk of damage to PC Board during assembly
- Allows for copper traces to run under the fastener which better utilizes space on the board
- Enhanced PC Board performance due to cut out of the fastener that allows for localized heat up of the area in contact with the solder

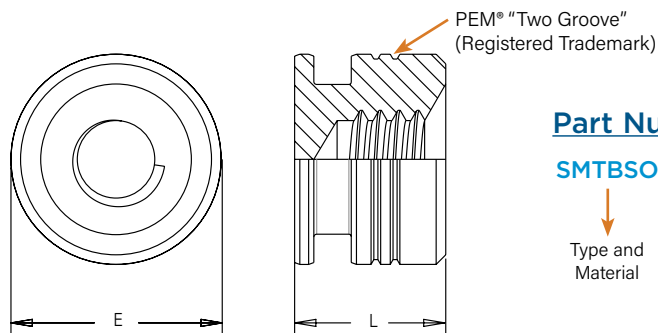
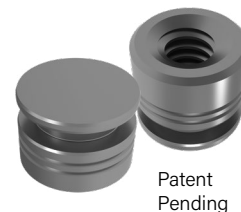

Part Number Designation

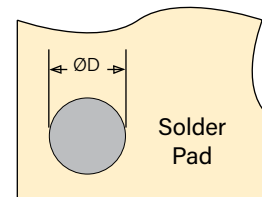

All dimensions are in inches.

Unified	Thread Size	Type	Thread Code	Length Code "L" ±.005 (Length code in 32nds of an inch)	E ±.005	ØD Min. Solder Pad	Number of Full Threads
				.187			
	.112-40 (#4-40)	SMTBSO	440	6	.219	.244	2.0

All dimensions are in millimeters.

Metric	Thread Size	Type	Thread Code	Length Code "L" ±0.13 (Length code in millimeters)	E ±0.13	ØD Min. Solder Pad	Number of Full Threads
		M3 x 0.5	SMTBSO	M3	4	5.56	6.2

Number of Parts per Reel

Part Number	Number of Parts per Reel
SMTBSO-440-6ET	650
SMTBSO-M3-4ET	900

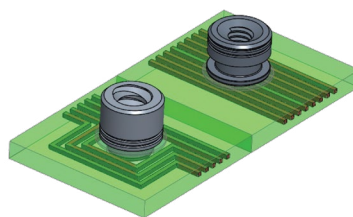

The SMTBSO™ fastener does not require a through hole allowing for copper traces to run under the fastener which better utilizes space on the board.

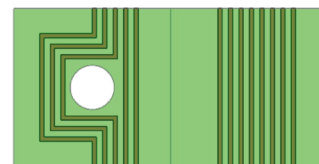

PC Board with through hole. PC Board without through hole.

SMTSO™/SMTSOB™ Reelfast® Surface Mount Nuts And Spacers/Standoffs

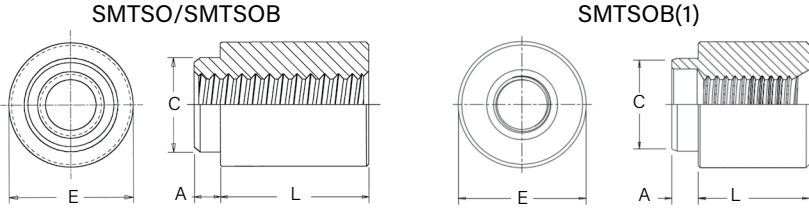

Thread/thru hole sizes 2-56, 4-40, 6-32, 8-32, 116, 143, M2, M2.5, M3, M3.5, M4, 3.1, 3.6, and 4.2

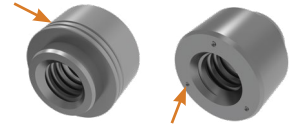

PEM® SMTSO and SMTSOB standoffs may be marked with either our "Two Groove" or "3 Dimple" registered trademarks.

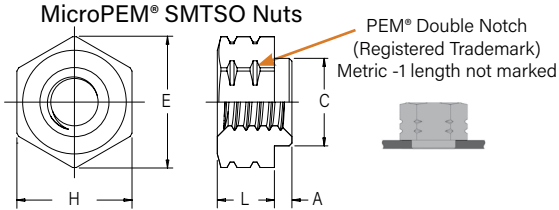

Thread sizes 080, S1, S1.2, S1.4 and M1.6

Part Number Designation

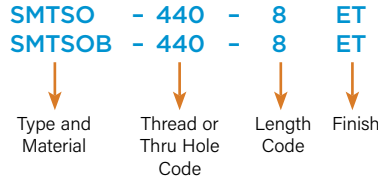

Stencil Masking Examples

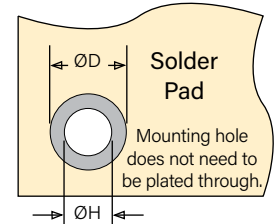
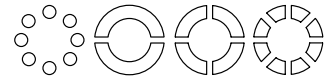

NOTE: Standoffs are available on special order without a pilot that do not require a thru hole for installation. Contact techsupport@pemnet.com for more information.

SMTSO™ fasteners available in copper upon request.

All dimensions are in inches.

Unified	Thread Size	Thru Hole +0.04 -0.03	Type		Thread or Thru Hole Code	Length Code "L" ±0.05 (Length code in 32nds of an inch)				Min. Sheet Thickness	A Max.	C Max.	E		H Nom.	ØH Hole Size In Sheet +0.03 -0.00	ØD Min. Solder Pad
			Fastener Material			.062	.125	.250	.375				Ref.	±0.05			
			Steel	Brass													
	.060-80 (#0-80)	-	SMTSO	-	080	2	4	-	-	.020	.019	.095	.144		.125	.098	.165
	.086-56 (#2-56)	-	SMTSO	SMTSOB	256	2	4	8 ⁽¹⁾	12 ⁽¹⁾	.060	.060	.142	-	.219	-	.147	.244
	.112-40 (#4-40)	-	SMTSO	SMTSOB	440	2	4	8 ⁽¹⁾	12 ⁽¹⁾	.060	.060	.161	-	.219	-	.166	.244
	.138-32 (#6-32)	-	SMTSO	SMTSOB	632	2	4	8 ⁽¹⁾	12 ⁽¹⁾	.060	.060	.208	-	.281	-	.213	.306
	.164-32 (#8-32)	-	SMTSO	SMTSOB	832	2	4	8 ⁽¹⁾	12 ⁽¹⁾	.060	.060	.245	-	.344	-	.250	.369
	-	.116	SMTSO	SMTSOB	116	2	4	8	12	.060	.060	.161	-	.219	-	.166	.244
	-	.143	SMTSO	SMTSOB	143	2	4	8	12	.060	.060	.208	-	.281	-	.213	.306

All dimensions are in millimeters.

Metric	Thread Size x Pitch	Thru Hole +0.10 -0.08	Type		Thread or Thru Hole Code	Length Code "L" ±0.13 (Length code in millimeters)						Min. Sheet Thickness	A Max.	C Max.	E		H Nom.	ØH Hole Size In Sheet +0.08	ØD Min. Solder Pad	
			Fastener Material			1	2	3	4	6	8				10	Ref.				±0.13
			Steel	Brass																
	S1	-	SMTSO	-	M1	1	2	3	-	-	-	0.5	0.48	2.41	3.66	-	3.18	2.5	4.19	
	S1.2	-	SMTSO	-	M1.2	1	2	3	-	-	-	0.5	0.48	2.41	3.66	-	3.18	2.5	4.19	
	S1.4	-	SMTSO	-	M1.4	1	2	3	-	-	-	0.5	0.48	2.41	3.66	-	3.18	2.5	4.19	
	M1.6 x 0.35	-	SMTSO	-	M1.6	1	2	3	-	-	-	0.5	0.48	2.41	3.66	-	3.18	2.5	4.19	
	M2 x 0.4	-	SMTSO	SMTSOB	M2	-	2	3	4 ⁽¹⁾	6 ⁽¹⁾	8 ⁽¹⁾	10 ⁽¹⁾	1.53	1.53	3.6	-	5.56	-	3.73	6.2
	M2.5 x 0.45	-	SMTSO	SMTSOB	M2.5	-	2	3	4 ⁽¹⁾	6 ⁽¹⁾	8 ⁽¹⁾	10 ⁽¹⁾	1.53	1.53	4.09	-	5.56	-	4.22	6.2
	M3 x 0.5	-	SMTSO	SMTSOB	M3	-	2	3	4 ⁽¹⁾	6 ⁽¹⁾	8 ⁽¹⁾	10 ⁽¹⁾	1.53	1.53	4.09	-	5.56	-	4.22	6.2
	M3.5 x 0.6	-	SMTSO	SMTSOB	M3.5	-	2	3	4 ⁽¹⁾	6 ⁽¹⁾	8 ⁽¹⁾	10 ⁽¹⁾	1.53	1.53	5.28	-	7.14	-	5.41	7.77
	M4 x 0.7	-	SMTSO	SMTSOB	M4	-	2	3	4	6 ⁽¹⁾	8 ⁽¹⁾	10 ⁽¹⁾	1.53	1.53	6.22	-	8.74	-	6.35	9.37
	-	3.1	SMTSO	SMTSOB	3.1	-	2	3	4	6	8	10	1.53	1.53	4.09	-	5.56	-	4.22	6.2
	-	3.6	SMTSO	SMTSOB	3.6	-	2	3	4	6	8	10	1.53	1.53	5.28	-	7.14	-	5.41	7.77
	-	4.2	SMTSO	SMTSOB	4.2	-	2	3	4	6	8	10	1.53	1.53	6.22	-	8.74	-	6.35	9.37

(1) SMTSOB fasteners with this length code have a shank counterbore.

Number Of Parts Per Reel / Pitch (MM) For Each Size

Thread/Thru-Hole Size	Length Code							
	1	2	3	4	6	8	10	12
080	-	3500 / 8	-	2000 / 8	-	-	-	-
256, 440, 632, 116, 143	-	1500 / 12	-	1000 / 12	-	650 / 12	-	300 / 16
832	-	1100 / 16	-	800 / 16	-	500 / 16	-	300 / 16
M1, M1.2, M1.4, M1.6	3500 / 8	2500 / 8	2000 / 8	-	-	-	-	-
M2, M2.5, M3, M3.5, 3.1, 3.6	-	1500 / 12	1000 / 12	900 / 12	650 / 12	375 / 16	300 / 16	-
M4, 4.2	-	1100 / 16	800 / 16	675 / 16	500 / 16	375 / 16	300 / 16	-

Packaged on 330 mm recyclable reels. Tape width is 24 mm. Reels conform to EIA-481.

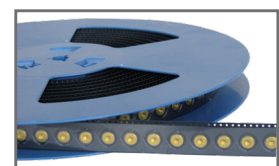

A polyimide patch is supplied to allow for reliable vacuum pickup. Fasteners are also available without a patch which may provide a lower cost alternative, depending on your installation methods/requirements.

SMTSS™ Reelfast® Snap-Top® Standoffs

NOTE: REELFAST® SNAP-TOP® SMTSS™ standoffs are for on-only applications. For removal applications, mounting hole A can be increased to reduce removal force.

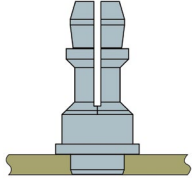
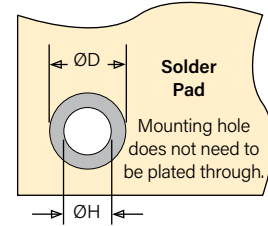
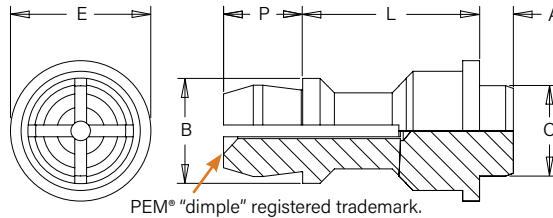

Part Number Designation

SMTSS S - 156 - 12 ET

↓ ↓ ↓ ↓ ↓
 Type Material Top Board Length Finish
 Mounting Hole Code
 A Diameter Code

Stencil Masking Examples

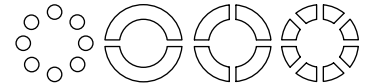

All dimensions are in inches.

Unified	Top Board Mounting Hole A Diameter Code	Type and Material	Length Code "L" ±.005 (Length Code in 32nds of an inch)		Min. Sheet Thickness	A Max.	C Max.	E ±.005	B ±.005	P ±.005	ØH Hole Size in Sheet +.003 -.000	ØD Min. Solder Pad
			.250	.375								
	156	SMTSSS	8	12	.060	.060	.161	.250	.188	.141	.166	.276

All dimensions are in millimeters.

Metric	Top Board Mounting Hole A Diameter Code	Type and Material	Length Code "L" ±0.13 (Length Code in millimeters)			Min. Sheet Thickness	A Max.	C Max.	E ±0.13	B ±0.13	P ±0.13	ØH Hole Size in Sheet +0.08	ØD Min. Solder Pad
			6	8	10								
	4MM	SMTSSS	6	8	10	1.53	1.53	4.09	6.35	4.8	3.58	4.22	7

Number Of Parts Per Reel

Type, Material and Size	Length Code / Number of Parts per Reel		
SMTSSS-156	-8 / 280	-12 / 220	
SMTSSS-4MM	-6 / 300	-8 / 250	-10 / 200

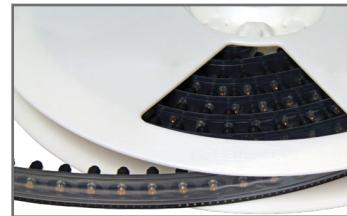

Packaged on 330 mm recyclable reels. Tape width is 24 mm. Supplied with polyimide patch for vacuum pick up. Reels conform to EIA-481.

SMTSS™ Application Data

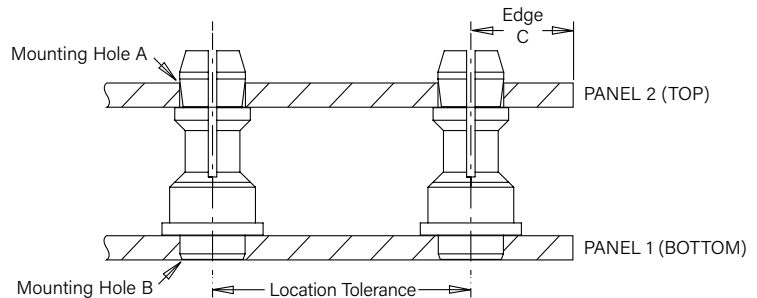

All dimensions are in inches.

Unified	Type	Panel 1					Panel 2				
		Hardness Max.	Bottom Mounting Hole B +.003 -.000	Panel Material	Thickness Min.	Location Tolerance	Hardness Max.	Top Mounting Hole A +.003 -.000	Panel Material	Thickness Range	Edge Distance C Min.
	SMTSS	No Limit	.166	PC board	.060	±.005	No Limit	.156	PC board or Metal	.040 - .070	.100

All dimensions are in millimeters.

Metric	Type	Panel 1					Panel 2				
		Hardness Max.	Bottom Mounting Hole B +0.08	Panel Material	Thickness Min.	Location Tolerance	Hardness Max.	Top Mounting Hole A +0.08	Panel Material	Thickness Range	Edge Distance C Min.
	SMTSS	No Limit	4.22	PC board	1.53	±0.13	No Limit	4	PC board or Metal	1 - 1.8	2.54

SMTSK™ Reelfast® Keyhole® Standoffs

- Unique barrel design allows for quick attachment and detachment.
- Makes horizontal or vertical component mounting possible.

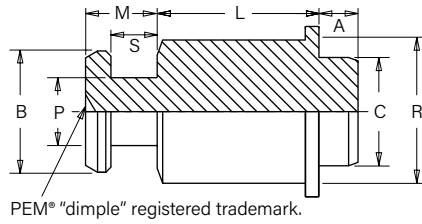

PEM® "dimple" registered trademark.

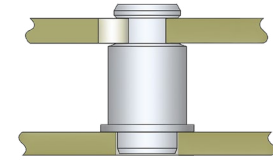
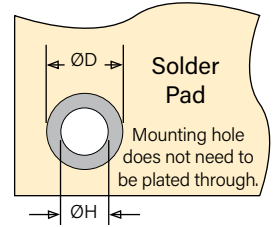

Part Number Designation

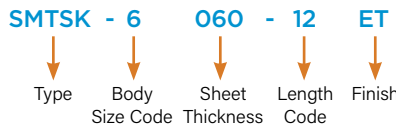

Stencil Masking Examples

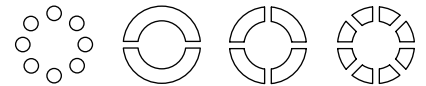

All dimensions are in inches.

Unified	Type	Body Size - Sheet Code	Length "L" ± .005 (Length Code in 32nds of an inch)			Min. Sheet Thickness	A Max.	C Max.	E ±.005	B ±.003	P ±.003	R Max.	S ±.003	M Max.	ØH Hole Size in Sheet +.003 -.000	ØD Min. Solder Pad
			.125	.250	.375											
SMTSK	6060	4	8	12	.060	.060	.161	.250	.177	.099	.212	.068	.108	.166	.276	

All dimensions are in millimeters.

Metric	Type	Body Size - Sheet Code	Length "L" ± 0.13 (Length Code in millimeters)					Min. Sheet Thickness	A Max.	C Max.	E ±0.13	B ±0.08	P ±0.08	R Max.	S ±0.08	M Max.	ØH Hole Size in Sheet +0.08	ØD Min. Solder Pad
			3	4	6	8	10											
SMTSK	61.5	3	4	6	8	10	1.53	1.53	4.09	6.35	4.5	2.51	5.39	1.73	2.75	4.22	7	

Number Of Parts Per Reel

Part Number	Length Code "L"		
	.125	.250	.375
SMTSK-6060	4	8	12
	630	440	230

Part Number	Length Code "L"				
	3	4	6	8	10
SMTSK-61.5	640	540	1000	260	220



Packaged on 13" recyclable reels. Tape width is 24mm and 16mm. Pitch is 16mm and 12mm. Reels conform to EIA-481.

Application Data

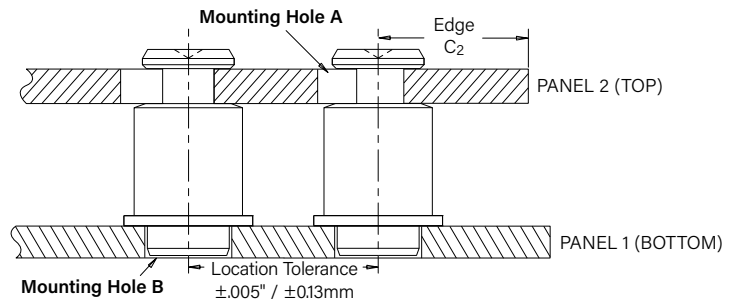
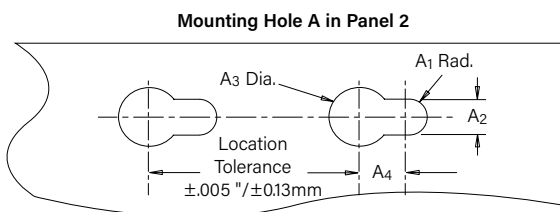

All dimensions are in inches.

Unified	Type	Panel 1					Panel 2						
		Hardness Max.	Bottom Mounting Hole B +.003 -.000	Panel Material	Thickness Min.	Location Tolerance	Top Mounting Hole A				Panel Material	Thickness Range	Edge Distance C2 Min.
							A1 Nom.	A2 ±.003	A3 ±.003	A4 Min.			
SMTSK	No Limit	.166	PC board	.060	±.005	.059	.118	.197	.148	ANY	.057 - .064	.160	

All dimensions are in millimeters.

Metric	Type	Panel 1					Panel 2						
		Hardness Max.	Bottom Mounting Hole B +0.08	Panel Material	Thickness Min.	Location Tolerance	Top Mounting Hole A				Panel Material	Thickness Range	Edge Distance C2 Min.
							A1 Nom.	A2 ±0.08	A3 ±0.08	A4 Min.			
SMTSK	No Limit	4.22	PC board	1.53	±0.13	1.5	3	5	3.75	ANY	1.45 - 1.62	4.1	

Note About Plated And Unplated Mounting Holes For Broaching Fasteners

Broaching and broach/flare types are designed for unplated mounting hole applications. If used in plated mounting holes, the stresses involved can damage the plating, push out the plating entirely, or break any traces inside the board that might be connected to the plated hole. When installing into non-plated mounting holes there may even be issues with delamination, measeling or crazing in some instances.

Increasing the mounting hole size +.005" to +.008" / +0.13 mm to +0.2 mm may relieve these conditions. If increasing the mounting hole does not correct the issue then we recommend our surface-mount type fasteners.

It is always recommended that you try the fasteners in your specific application before full production begins. We are happy to provide samples for this purpose.

General recommendations for "Keep Out" areas are the same as our "Min. Distance Hole C/L to Edge" dimensions stated in the dimensional charts of our bulletin.

KFE™/KFSE™ Broaching Standoffs

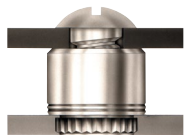

Part Number Designation

KFSE - 632 - 12
 KFE - 632 - 12 ET

↓ ↓ ↓ ↓
 Type and Material Thread or Thru Hole Code Length Code Finish

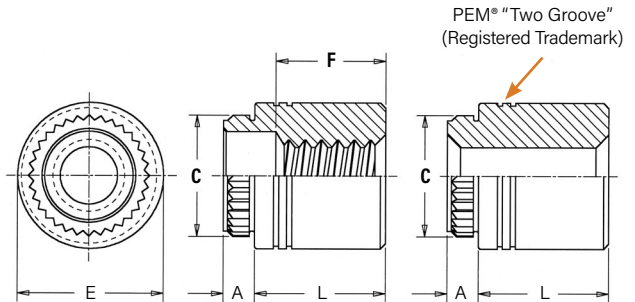

PEM® "Two Groove" (Registered Trademark)

All dimensions are in inches.

Unified	Thread Size	Thru Hole +.004 -.003	Type		Thread or Thru Hole Code	Length "L" ±.005 (Length Code is in 32nds of an inch)							A (Shank) Max.	Min. Sheet Thickness	Hole Size In Sheet +.003 - .000	C ±.003	E ±.005	Min. Dist. Hole C/L to Edge (2)	
			Carbon Steel	Stainless Steel		.125	.250	.375	.500	.625	(1) .750	(1) .875							(1) 1.00
	.112-40 (#4-40)	—	—	KFE	KFSE	440	4	8	12	16	20	24	—	—	.060	.060	.166	.184	.219
.138-32 (#6-32)	—	—	KFE	KFSE	632	4	8	12	16	20	24	28	32	.060	.060	.213	.231	.281	.22
—	.116	—	KFE	KFSE	116	4	8	12	16	20	24	—	—	.060	.060	.166	.184	.219	.17
—	.143	—	KFE	KFSE	143	4	8	12	16	20	24	28	32	.060	.060	.213	.231	.281	.22
"F" Minimum Thread Length (Where Applicable)						Full			.375 ± .016		.375 Blind								

All dimensions are in millimeters.

Metric	Thread Size x Pitch	Thru Hole +0.10 -0.08	Type		Thread or Thru Hole Code	Length "L" ±0.13 (Length Code is in millimeters)							A (Shank) Max.	Min. Sheet Thickness	Hole Size In Sheet +0.08	C ±0.08	E ±0.13	Min. Dist. Hole C/L to Edge (2)	
			Carbon Steel	Stainless Steel		3	4	6	8	10	12	14							16
	M3 x 0.5	—	—	KFE	KFSE	M3	3	4	6	8	10	12	14	16	1.53	1.53	4.22	4.68	5.56
—	3.6	—	KFE	KFSE	3.6	3	4	6	8	10	12	14	16	1.53	1.53	5.41	5.87	7.14	5.5
—	4.2	—	KFE	KFSE	4.2	3	4	6	8	10	12	14	16	1.53	1.53	6.4	6.81	8.74	7.1
"F" Minimum Thread Length (Where Applicable)						Full			9.5										

- (1) Blind at shank end with .375" minimum thread length from head end.
- (2) For more information on proximity to bends and distance to other clinch hardware, see [PEM® Tech Sheet C/L To Edge](#).

KF2™/KFS2™ Broaching Nuts

- Can be used in aluminum, acrylic, casting and polycarbonate components

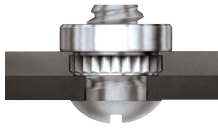

Part Number Designation

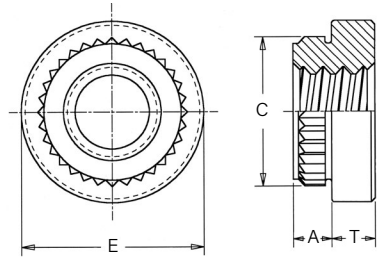
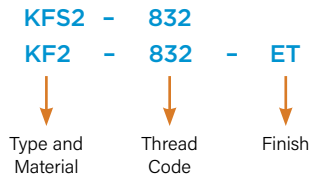

All dimensions are in inches.

Unified	Thread Size	Type		Thread Code	A (Shank) Max.	Min. Sheet Thickness	Hole Size In Sheet +.003 -.000	C ±.003	E ±.005	T ±.005	Min. Dist. Hole C/L to Edge (1)
		Carbon Steel	Stainless Steel								
	.086-56 (#2-56)	KF2	KFS2	256	.060	.060	.147	.165	.219	.065	0.16
	.112-40 (#4-40)	KF2	KFS2	440	.060	.060	.166	.184	.219	.065	0.17
	.138-32 (#6-32)	KF2	KFS2	632	.060	.060	.213	.231	.281	.065	0.22
	.164-32 (#8-32)	KF2	KFS2	832	.060	.060	.250	.268	.344	.096	0.25
	.190-32 (#10-32)	KF2	KFS2	032	.060	.060	.272	.290	.375	.127	0.28

All dimensions are in millimeters.

Metric	Thread Size x Pitch	Type		Thread Code	A (Shank) Max.	Min. Sheet Thickness	Hole Size In Sheet +0.08	C ±0.08	E ±0.13	T ±0.13	Min. Dist. Hole C/L to Edge (1)
		Carbon Steel	Stainless Steel								
	M2 x 0.4	KF2	KFS2	M2	1.53	1.53	3.73	4.19	5.56	1.5	4.2
	M2.5 x 0.45	KF2	KFS2	M2.5	1.53	1.53	4.22	4.68	5.56	1.5	4.4
	M3 x 0.5	KF2	KFS2	M3	1.53	1.53	4.22	4.68	5.56	1.5	4.4
	M4 x 0.7	KF2	KFS2	M4	1.53	1.53	6.4	6.81	8.74	2	6.4
	M5 x 0.8	KF2	KFS2	M5	1.53	1.53	6.9	7.37	9.53	3	7.1

(1) For more information on proximity to bends and distance to other clinch hardware, see [PEM® Tech Sheet C/L To Edge](#).

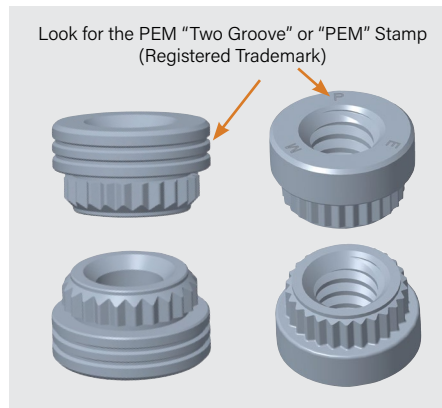

KFB3™ Broach/Flare-Mount Standoffs

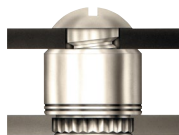

Part Number Designation

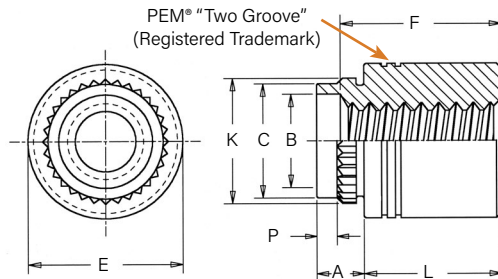
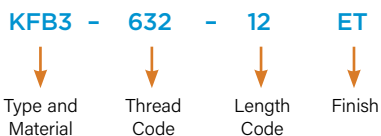

All dimensions are in inches.

Unified	Thread Size	Type	Thread Code	Length Code "L" ±.005 (Length code in 32nds of an inch)										A (shank) Max.	Sheet Thickness	Hole Size in Sheet +.005 -.001	B ±.003	C Max.	E ±.005	K ±.003	P ±.010	Min. Dist. Hole C/L to Edge (2)
				.062	.125	.187	.250	.312	.375	.500	.625	.750 (1)	1.00 (1)									
	.112-40 (#4-40)	KFB3	440	2	4	6	8	10	12	16	20	—	—	.09	.050-.065	.166	.122	.165	.219	.179	.040	.17
	.138-32 (#6-32)	KFB3	632	2	4	6	8	10	12	16	20	24	32	.09	.050-.065	.213	.171	.212	.280	.226	.040	.22
	.190-32 (#10-32)	KFB3	032	2	4	6	8	10	12	16	20	24	32	.09	.050-.065	.272	.228	.271	.375	.285	.040	.275
	.250-32 (1/4-20)	KFB3	0420	2	4	6	8	10	12	16	20	24	32	.09	.050-.065	.335	.283	.331	.437	.348	.040	.335
"F" Min. Thread Length (Where Applicable)				Full									.375 Blind									

All dimensions are in millimeters.

Metric	Thread Size x Pitch	Type	Thread Code	Length Code "L" ±0.13 (Length code in millimeters)										A (shank) Max.	Sheet Thickness	Hole Size in Sheet +0.13 -0.03	B ±0.08	C Max.	E ±0.13	K ±0.08	P ±0.25	Min. Dist. Hole C/L to Edge (2)
				2	3	4	6	8	10	12	14	16										
	M3 x 0.5	KFB3	M3	2	3	4	6	8	10	12	14	16	2.29	1.27-1.65	4.22	3.23	4.2	5.56	4.55	1	4.33	
	M4 x 0.7	KFB3	M4	2	3	4	6	8	10	12	14	16	2.29	1.27-1.65	6.4	5.23	6.33	8.74	6.68	1	6.36	
	M5 x 0.8	KFB3	M5	2	3	4	6	8	10	12	14	16	2.29	1.27-1.65	6.9	5.8	6.86	9.53	7.23	1	7	
	M6 x 1	KFB3	M6	2	3	4	6	8	10	12	14	16	2.29	1.27-1.65	8.5	7.2	8.4	11.1	8.83	1	8.5	
"F" Minimum Thread Length (Where Applicable)				Full									9.5									

- (1) Blind at shank end with .375" minimum thread length from head end.
- (2) For more information on proximity to bends and distance to other clinch hardware, see [PEM® Tech Sheet C/L To Edge](#).

KSSB™ Broaching Snap-Top® Standoffs

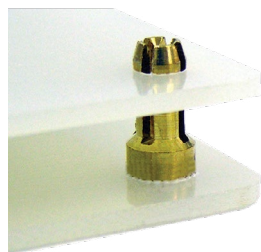

Part Number Designation

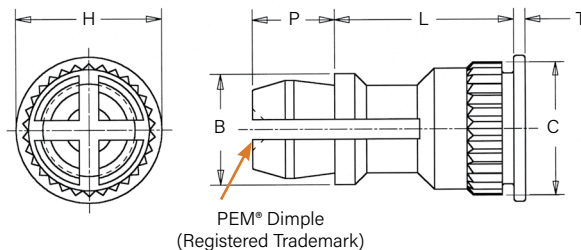
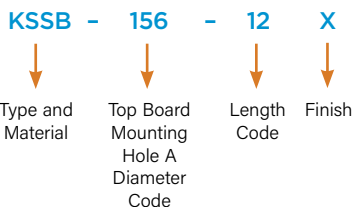

All dimensions are in inches.

Unified	Type	Top Board Mounting Hole A Diameter Code	Length "L" ±.005 (Length Code is in 32nds of an inch)										B ±.005	C ±.003	H ±.005	P ±.005	T ±.005
			.250	.312	.375	.437	.500	.562	.625	.750	.875	1.00					
	KSSB	156	8	10	12	14	16	18	20	24	28	32	.188	.226	.250	.141	.020

All dimensions are in millimeters.

Metric	Type	Top Board Mounting Hole A Diameter Code	Length "L" ±0.13 (Length Code is in millimeters)										B ±0.13	C ±0.08	H ±0.13	P ±0.13	T ±0.13
			8	10	12	14	16	18	20	22	25						
	KSSB	4MM	8	10	12	14	16	18	20	22	25	4.8	5.74	6.35	3.58	0.51	

KSSB™ Application Data

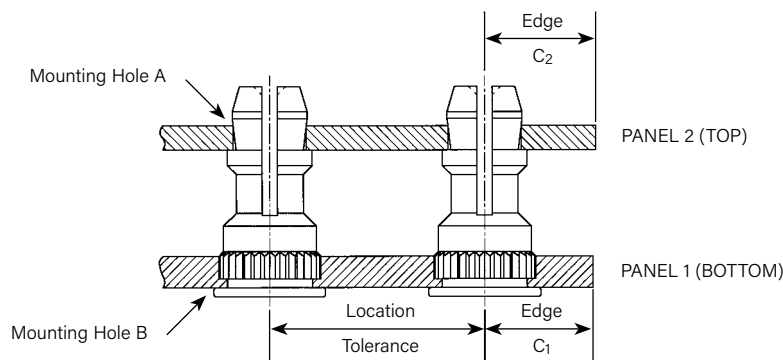

All dimensions are in inches.

Unified	Type	Panel 1						Panel 2				
		Hardness Max. (1)	Bottom Mounting Hole B +.003 -.000	Panel Material	Thickness Min.	Edge Distance C ₁ Min.	Location Tolerance	Hardness Max.	Top Mounting Hole A +.003 -.000	Panel Material	Thickness Range (2)	Edge Distance C ₂ Min.
	KSSB	HRB 65 / HB 116	.213	PC board	.050	.220	±.005	No Limit	.156	PC board or Metal	.040 - .070	.100

All dimensions are in millimeters.

Metric	Type	Panel 1						Panel 2				
		Hardness Max. (1)	Bottom Mounting Hole B +0.08	Panel Material	Thickness Min.	Edge Distance C ₁ Min.	Location Tolerance	Hardness Max.	Top Mounting Hole A +0.08	Panel Material	Thickness Range (2)	Edge Distance C ₂ Min.
	KSSB	HRB 65 / HB 116	5.41	PC board	1.27	5.59	±0.13	No Limit	4	PC board or Metal	1 - 1.8	2.54

(1) HRB - Hardness Rockwell "B" Scale, HB - Hardness Brinell.
 (2) Available for thicker boards on special order.

SMTPF LSM™ ReelFast® Surface Mount Captive Panel Screws

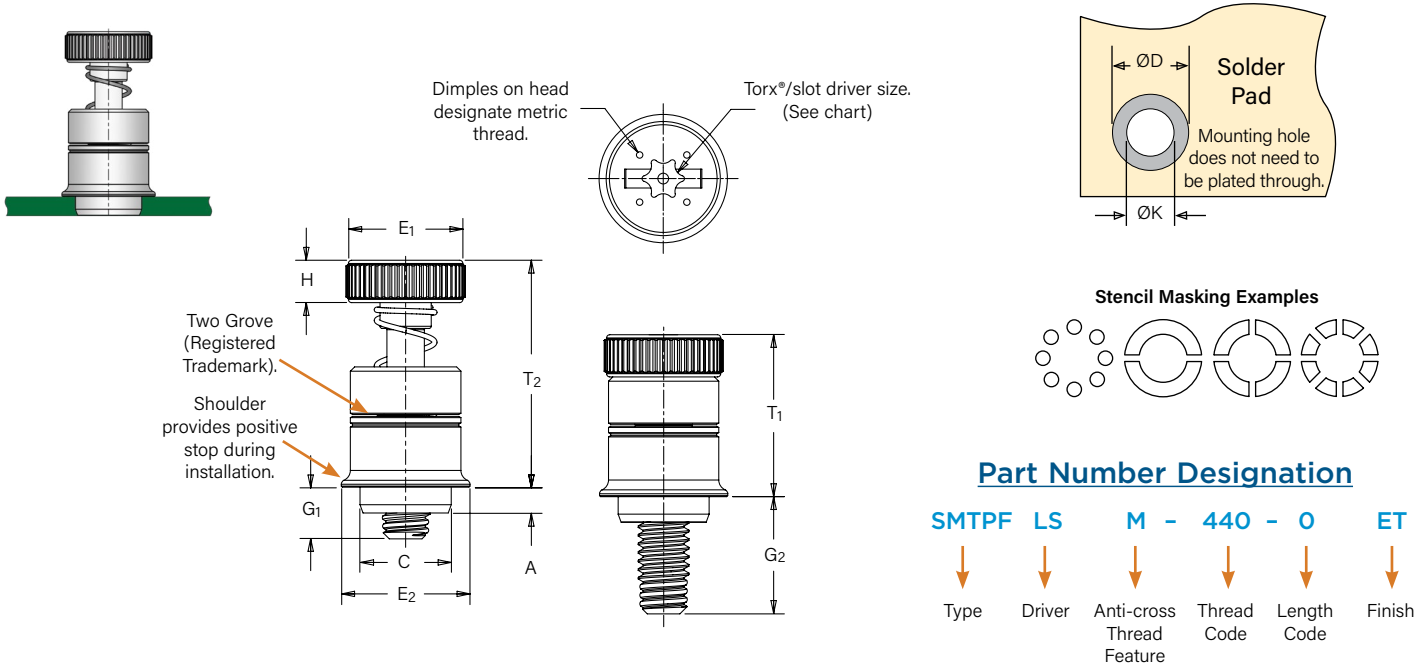

All dimensions are in inches.

Unified	Thread Size	Type	Thread Code	Screw Length Code	A (Shank) Max.	Min. Sheet Thickness	C Max.	E ₁ ±.010	E ₂ Nom	G ₁ ±.025	G ₂ ±.025	H ±.010	T ₁ Nom.	T ₂ Nom.	ØK Hole Size in Sheet +.003 -.000	ØD Min. Solder Pad	Driver Size
	.112-40 (#4-40)	SMTPF LSM	440	0	.063	.063	.215	.280	.300	.040	.210	.100	.38	.55	.220	.340	T15
				1						.100	.270						
.138-32 (#6-32)	SMTPF LSM	632	0	.063	.063	.247	.310	.320	.040	.240	.100	.42	.62	.252	.400	T15	
			1						.100	.300							

All dimensions are in millimeters.

Metric	Thread Size	Type	Thread Code	Screw Length Code	A (Shank) Max.	Min. Sheet Thickness	C Max.	E ₁ ±0.25	E ₂ Nom	G ₁ ±0.64	G ₂ ±0.64	H ±0.25	T ₁ Nom.	T ₂ Nom.	ØK Hole Size in Sheet +0.08	ØD Min. Solder Pad	Driver Size	
	M3 x 0.5	SMTPF LSM	M3	M3	0	1.6	1.6	5.46	7	76	1	5.3	2.5	9.6	14	5.6	8.6	T15
					1						2.5	6.8						
M3.5 x 0.6	SMTPF LSM	M3.5	M3.5	0	1.6	1.6	6.27	79	813	1	6.1	2.5	10.7	15.7	6.4	10.2	T15	
				1						2.5	7.62							

Number Of Parts Per Reel

Thread Size	Parts Per Reel
440	200
632	150
M3	200
M3.5	150



Packaged on 330 mm recyclable reels. Tape width is 24 mm. Supplied with polyimide patch for vacuum pick up. Reels conform to EIA-481.

SMPF™ ReelFast® Surface Mount Captive Panel Screws

Patented.

When Assembled

Spring action of plastic "fingers" holds screw in retracted position.

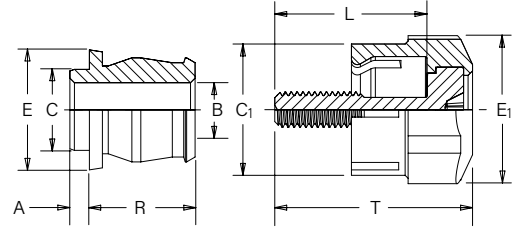
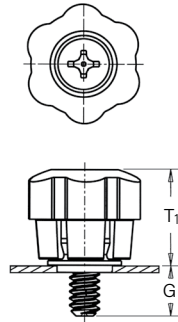
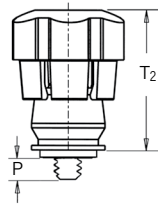
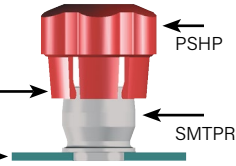

All dimensions are in inches.

Unified	Thread Size	Screw Part Number			Retainer Part Number	Assembly Dimensions					Screw Dimensions				Retainer Dimensions					
		Type	Thread Code	Screw Length Code		G ±.025	P ±.025	T ₁ Nom.	T ₂ Nom.	Total Radial Float	C ₁ ±.010	E ₁ ±.010	L ±.015	T Nom.	A (Shank) Max.	Min. Sheet Thick.	B ±.003	C Max.	E Nom.	R ±.005
#4-40	.112-40	PSHP	440	0	SMTPR-6-1	.188	.000	.478	.646	.015	.440	.542	.510	.663	.060	.060	.167	.249	.375	.325
				1		.248	.026						.570	.723						
#6-32	.138-32	PSHP	632	0	SMTPR-6-1	.188	.000	.478	.646	.020	.440	.542	.510	.663	.060	.060	.167	.249	.375	.325
				1		.248	.026						.570	.723						

All dimensions are in millimeters.

Metric	Thread Size x Pitch	Screw Part Number			Retainer Part Number	Assembly Dimensions					Screw Dimensions				Retainer Dimensions					
		Type	Thread Code	Screw Length Code		G ±.064	P ±.064	T ₁ Nom.	T ₂ Nom.	Total Radial Float	C ₁ ±0.25	E ₁ ±0.25	L ±0.38	T Nom.	A (Shank) Max.	Min. Sheet Thick.	B ±0.08	C Max.	E Nom.	R ±0.03
M3 x 0.5	M3	PSHP	M3	0	SMTPR-6-1	4.78	0	12.14	16.41	.38	11.18	13.77	12.95	16.84	1.53	1.53	4.24	6.33	9.53	8.26
				1		6.3	.66						14.48	18.36						
M3.5 x 0.6	M3.5	PSHP	M3.5	0	SMTPR-6-1	4.78	0	12.14	16.41	.51	11.18	13.77	12.95	16.84	1.53	1.53	4.24	6.33	9.53	8.26
				1		6.3	.66						14.48	18.36						

RETAINER — Packaged on 330 mm recyclable reels of 400 pieces. Tape width is 24 mm. Supplied with Kapton® patch for vacuum pick up. Reels conform to EIA-481.

SCREW — Packaged in bags. Retainers and screws are sold separately.

Part Number Designation For Screw

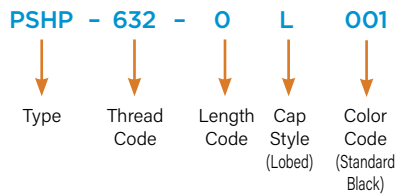

Part Number Designation For Retainer

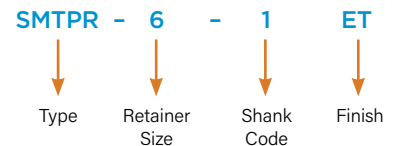

Color Capabilities For Type PSHP Screw

The colors shown here (codes #002 thru #007) are non-stocked standards and available on special order. Since actual cap colors may vary slightly from those shown here, we recommend that you request samples for color verification. If you require a custom color or you need a "color matched" cap, please contact us.

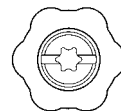
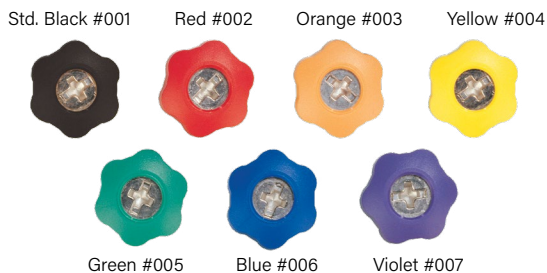

Available with Torx® recess on special order.

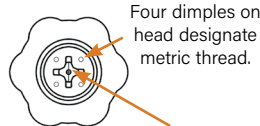

Metal Phillips Recess
#4-40 & M3 = #1
#6-32 & M3.5 = #2

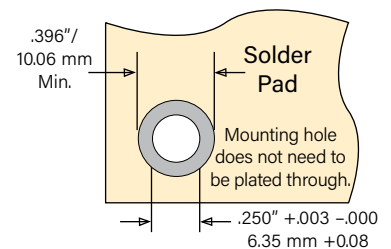

Stencil Masking Examples



Non-flammable UL 94-V0 plastic caps are available on special order.

PFK™ Broaching Captive Panel Screws

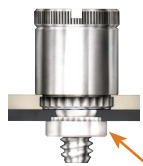

Shown here with self-clinching mating nut

Part Number Designation

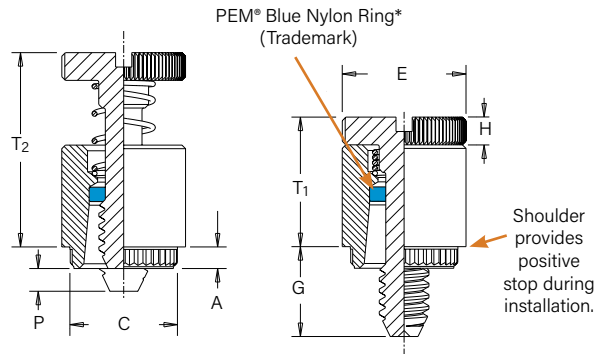
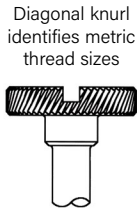
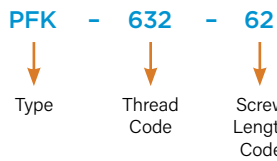

All dimensions are in inches.

Unified	Thread Size	Type	Thread Code	Screw Length Code	A (Shank) Max.	Min. Sheet Thickness	Hole Size In Sheet +.003 -.000	C ±.003	E ±.010	G ±.016	H ±.005	P ±.025	T ₁ Max.	T ₂ Nom.	Min. Dist. Hole C/L to Edge (1)
	.112-40 (#4-40)	PFK	440	440	40	.060	.060	.265	.283	.312	.250	.072	.000	.36	.54
62					.375						.125				
84					.500						.250				
.138-32 (#6-32)	PFK	632	632	40	.060	.060	.281	.299	.344	.250	.072	.000	.36	.54	.26
				62						.375		.125			
				84						.500		.250			

All dimensions are in millimeters.

Metric	Thread Size x Pitch	Type	Thread Code	Screw Length Code	A (Shank) Max.	Min. Sheet Thickness	Hole Size In Sheet +0.08	C ±0.08	E ±0.25	G ±0.4	H ±0.13	P ±0.64	T ₁ Max.	T ₂ Nom.	Min. Dist. Hole C/L to Edge (1)
	M3 x 0.5	PFK	M3	M3	40	1.53	1.53	6.73	7.19	7.92	6.4	1.83	0	9.14	13.72
62					9.5						3.2				
84					12.7						6.4				

*Retaining rings are plastic with normal 250°F / 120°C temperature limit.

KFH™ Broaching Studs



Part Number Designation

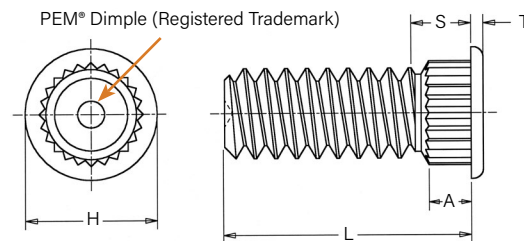
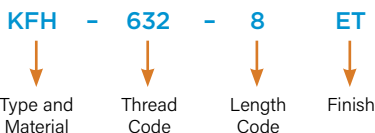

All dimensions are in inches.

Unified	Thread Size	Type	Thread Code	Length Code "L" ±.010 (Length code in 16ths of an inch)					A (Shank) Max.	Min. Sheet Thickness	Hole Size in Sheet +.003 -.000	Max. Hole Size in Attached Parts	H ±.010	S Max. (2)	T ±.005	Min. Dist. Hole C/L to Edge (1)	
				.250	.312	.375	.500	.625									.750
.112-40 (#4-40)	KFH	440	440	4	5	6	8	10	12	.065	.060	.120	.145	.180	.09	.020	.15
				4	5	6	8	10	12								
				4	5	6	8	10	12								
				4	5	6	8	10	12								
.138-32 (#6-32)	KFH	632	632	4	5	6	8	10	12	.065	.060	.140	.170	.200	.09	.020	.19
				4	5	6	8	10	12								
				4	5	6	8	10	12								
				4	5	6	8	10	12								
.164-32 (#8-32)	KFH	832	832	4	5	6	8	10	12	.065	.060	.166	.195	.225	.09	.020	.20
				4	5	6	8	10	12								
				4	5	6	8	10	12								
				4	5	6	8	10	12								
.190-32 (#10-32)	KFH	032	032	4	5	6	8	10	12	.065	.060	.189	.220	.250	.09	.020	.20
				4	5	6	8	10	12								
				4	5	6	8	10	12								
				4	5	6	8	10	12								

All dimensions are in millimeters.

Metric	Thread Size x Pitch	Type	Thread Code	Length Code "L" ±0.25 (Length code in millimeters)					A (Shank) Max.	Min. Sheet Thickness	Hole Size in Sheet +0.08	Max. Hole Size in Attached Parts	H ±0.25	S Max. (2)	T ±0.13	Min. Dist. Hole C/L to Edge (1)	
				6	8	10	12	15									18
M3 x 0.5	KFH	M3	M3	6	8	10	12	15	18	1.65	1.53	3	3.7	4.58	2.3	0.51	3.8
				6	8	10	12	15	18								
				6	8	10	12	15	18								
M4 x 0.7	KFH	M4	M4	6	8	10	12	15	18	1.65	1.53	4.2	4.8	5.74	2.3	0.51	5.1
				6	8	10	12	15	18								
				6	8	10	12	15	18								
M5 x 0.8	KFH	M5	M5	6	8	10	12	15	18	1.65	1.53	5	5.8	6.6	2.3	0.51	5.3
				6	8	10	12	15	18								
				6	8	10	12	15	18								

(1) For more information on proximity to bends and distance to other clinch hardware, see [PEM® Tech Sheet C/L To Edge](#).

(2) Threads are gaugeable to within 2 pitches of the "S" Max. dimension. A class 3B/5H maximum material commercial nut shall pass up to the "S" Max. dimension.

SMTRA™ ReelFast® Surface Mount Right Angle (R'angle®) Fasteners

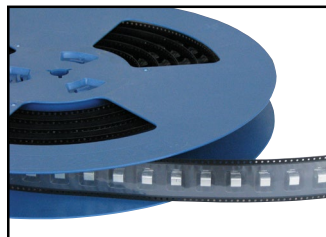

Part Number Designation



Patented.

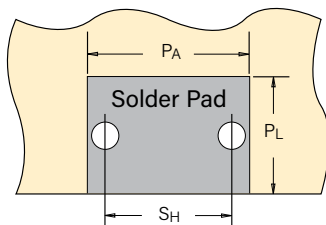

Solder pad can be flush to edge.
Mounting holes do not need to be plated through.

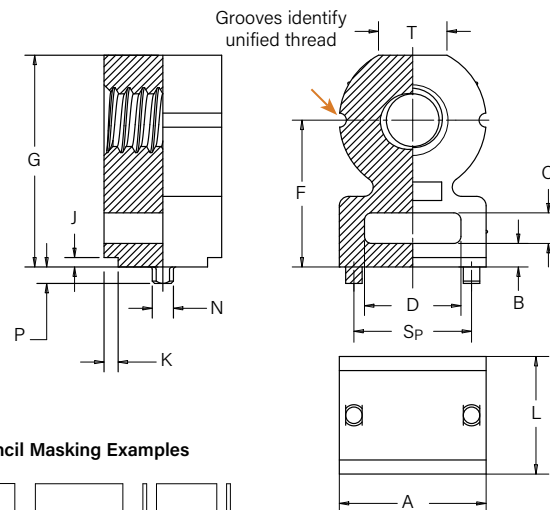

Stencil Masking Examples



All dimensions are in inches.

Unified	Thread Size	Type	Thread Code	Height Code	Length Code	Length L ±.005	Min. Sheet Thickness	Hole Size In Sheet +.003 -.000	A ±.006	B ±.006	C ±.006	D ±.006	Height F ±.006	G ±.006	J Nom.	K Nom.	N Max.	P Max.	Sp ±.003	T Nom.
	.086-56 (#2-56)	SMTRA	256	8	6	.188	.040	.053	.218	.040	.060	.140	.250	.345	.020	.030	.048	.040	.157	.105
	.112-40 (#4-40)	SMTRA	440	9	6	.188	.040	.053	.250	.050	.065	.160	.281	.390	.020	.030	.048	.040	.188	.125
	.138-32 (#6-32)	SMTRA	632	10	8	.250	.040	.053	.312	.050	.065	.205	.312	.450	.020	.030	.048	.040	.250	.145
	.164-32 (#8-32)	SMTRA	832	12	9	.281	.040	.053	.375	.050	.075	.250	.375	.535	.020	.030	.048	.040	.312	.195

All dimensions are in millimeters.

Metric	Thread Size x Pitch	Type	Thread Code	Height Code	Length Code	Length L ±0.13	Min. Sheet Thickness	Hole Size In Sheet +0.08	A ±0.15	B ±0.15	C ±0.15	D ±0.15	Height F ±0.15	G ±0.15	J Nom.	K Nom.	N Max.	P Max.	Sp ±0.08	T Nom.
	M2 x 0.4	SMTRA	M2	6	5	5	1	1.35	5.5	1	1.5	3.5	6	8.4	0.5	0.75	1.22	1	4	2.65
	M2.5 x 0.45	SMTRA	M25	6	5	5	1	1.35	5.5	1	1.5	3.5	6	8.4	0.5	0.75	1.22	1	4	2.65
	M3 x 0.5	SMTRA	M3	7	5	5	1	1.35	6.35	1.25	1.65	4	7	9.75	0.5	0.75	1.22	1	4.75	3.2
	M4 x 0.7	SMTRA	M4	9	7	7	1	1.35	9.53	1.25	1.65	6.35	9	13.1	0.5	0.75	1.22	1	7.9	4.8

Unified	Thread Code	Pad Width PA Min.	Pad Length PL Min.	Hole Spacing SH ±.002	Hole Size In Sheet +.003 -.000
	256	.262	.171	.157	.053
	440	.294	.171	.188	.053
	632	.356	.233	.250	.053
	832	.419	.264	.312	.053

Metric	Thread Code	Pad Width PA Min.	Pad Length PL Min.	Hole Spacing SH ±0.05	Hole Size In Sheet +0.08
	M2	6.62	4.57	4	1.35
	M25	6.62	4.57	4	1.35
	M3	7.47	4.57	4.75	1.35
	M4	10.65	6.57	7.9	1.35

Part Number	Parts Per Reel	Pitch (mm)	Tape Width (mm)
SMTRA256-8-6	375	16	24
SMTRA440-9-6	300	16	24
SMTRA632-10-8	200	20	32
SMTRA832-12-9	200	20	32
SMTRAM2-6-5	375	16	24
SMTRAM25-6-5	375	16	24
SMTRAM3-7-5	300	16	24
SMTRAM4-9-7	200	20	32

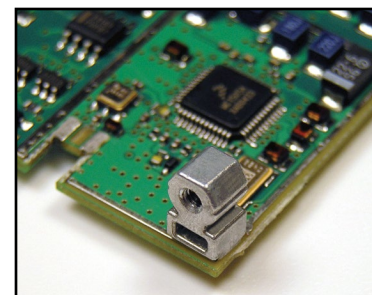

SFK™ SpotFast® Clinch/Broach Mount Fasteners

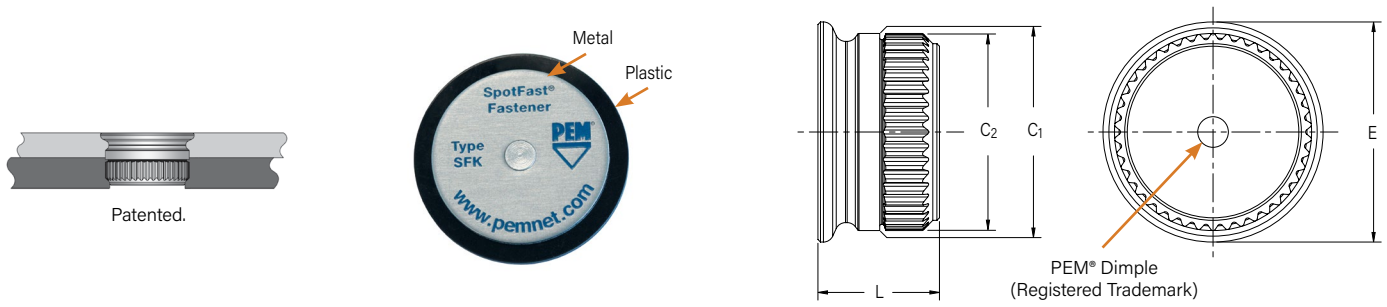

Type and Size	Thickness Code	Panel 1				Panel 2				C ₁ Max.		C ₂ ±0.08 mm / ±.003"		E Max.		L Max.		Min. Dist. Hole C/L to Edge (2)	
		Thickness ±0.08 mm / ±.003"		Mounting Hole +0.08 mm / +.003" - .000"		Thickness Min. (1)		Mounting Hole +0.08 mm / +.003" - .000"											
		mm	in.	mm	in.	mm	in.	mm	in.	mm	in.	mm	in.	mm	in.	mm	in.		
SFK-3	0.8	0.8	.031	3	.118	1.6	.063	2.5	.098	2.98	.117	2.9	.114	3.53	.139	2.31	.091	3	0.12
SFK-3	1.0	1	.039	3	.118	1.6	.063	2.5	.098	2.98	.117	2.9	.114	3.76	.148	2.51	.099	3	0.12
SFK-3	1.2	1.2	.047	3	.118	1.6	.063	2.5	.098	2.98	.117	2.9	.114	3.76	.148	2.72	.107	3	0.12
SFK-3	1.6	1.6	.063	3	.118	1.6	.063	2.5	.098	2.98	.117	2.9	.114	3.76	.148	3.12	.123	3	0.12
SFK-5	0.8	0.8	.031	5	.197	1.6	.063	4.5	.177	4.98	.196	4.9	.193	5.56	.219	2.31	.091	5.1	0.20
SFK-5	1.0	1	.039	5	.197	1.6	.063	4.5	.177	4.98	.196	4.9	.193	5.56	.219	2.51	.099	5.1	0.20
SFK-5	1.2	1.2	.047	5	.197	1.6	.063	4.5	.177	4.98	.196	4.9	.193	5.56	.219	2.72	.107	5.1	0.20
SFK-5	1.6	1.6	.063	5	.197	1.6	.063	4.5	.177	4.98	.196	4.9	.193	5.56	.219	3.12	.123	5.1	0.20

- (1) Fastener will provide flush application at minimum sheet thickness.
- (2) For more information on proximity to bends and distance to other clinch hardware, see [PEM® Tech Sheet C/L To Edge](#).



Can be used as a single flush-mounted pivot point. For more information, please contact techsupport@pemnet.com

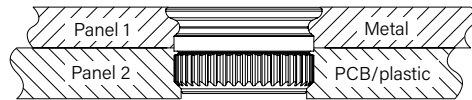

Type SFK joining metal to PCB/plastic.

Part Number Designation

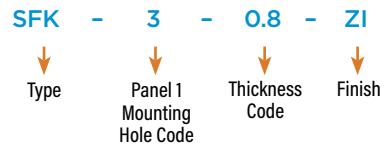

Material And Finish Specifications

Type	Threads (1)		Fastener Materials					Standard Finishes			Optional Finish		For Use in Sheet Hardness: (3)				
	Internal, ASME B1.12B/ASME B1.13M 6H	External, ASME B1.12A/ASME B1.13M 6g	Lead-Free Carbon Steel	300 Series Stainless Steel	CDA-510 Phosphor Bronze	Brass	Nylon, Temp. Limit 200° F / 93° C	Passivated and/or Tested Per ASTM A380	Electro-Plated Tin ASTM B 545, Class B With Clear Preservative Coating, annealed (4)	No Finish	Electro-Plated Tin ASTM B 545, Class B With Clear Preservative Coating, annealed (4)	Black Nitride	HRB 70 / HB 125 or Less	HRB 65 / HB 116 or Less	HRB 60 / HB 107 or Less	HRB 55 / HB 96 or Less	Aluminum, Acrylic, Castings, Polycarbonate, and PC board
KF2	
KFS2	
KFE	
KFSE	
KFB3	
KSSB							
KFH		
PFK Retainer				
Screw		
Spring				.												.	
Retaining Ring							.									.	
Part Number Codes For Finishes							None	ET	X	ET	BN						

Type	Threads (1)		Fastener Materials					Standard Finishes (2)			For Use in Sheet Hardness: (3)	
	Miniature ISO 1501, 4H6	Internal, ASME B1.12B/ASME B1.13M 6H	External, ASME B1.12A/ASME B1.13M 6g	Lead-Free Carbon Steel	Hardened Carbon Steel	300 Series Stainless Steel	Brass	Zinc Diecast	Zinc Plated per ASTM B633, SC1 (5µm), Type III, Colorless	Electro-Plated Tin ASTM B 545, Class A With Clear Preservative Coating, annealed (4)	Bright Nickel Over Copper Flash	HRB 80 / HB 150 or less
SMTSO	S1 to S1.4	0-80 to 8-32/ M1.6 to M4		.					.			.
SMTSOB		.					.		(6)			.
SMTBSO	
SMTRA	
SMTPLSM												
Retainer				.					.			.
Screw				.					.			.
Spring						.						.
PSHP (5)				.						.		.
SMTPR				.					.			.
SFK			
SMTSSS				.					.			.
SMTSK				.					.			.
Part Number Codes For Finishes								ZI	ET	CN		

(1) For plated studs, Class 2A/6g, the maximum major and pitch diameter, after plating, may equal basic sizes and can be gauged to Class 3A/6h, per ASME B1.1 Section 7, Paragraph 2 and ASME B113M, Section 8, Paragraph 8.2.
 (2) See PEM Technical Support section of our web site for related plating standards and specifications.
 (3) HRB - Hardness Rockwell "B" Scale. HB - Hardness Brinell.
 (4) Optimal solderability life noted on packaging.
 (5) ABS cap on PSHP screw has a temperature limit of 200° F / 93° C.
 (6) The tin deposit on type SMTSOB meets the requirements of ASTM B545, Class A and although the copper and nickel barrier layers used under the tin do not strictly comply with ASTM B545 thickness requirements they have proven effective at preventing zinc migration and providing the specified solderable shelf life.

Installation

KF2™/KFS2™/KFE™/KFSE™/PFK™ Fasteners

1. Prepare properly sized mounting hole in board.
2. Place fastener into the anvil hole and place the mounting hole over the shank of the fastener as shown in drawing.
3. With installation punch and anvil surfaces parallel, apply squeezing force until shoulder contacts the board.

PEMSERTER® Installation Tooling (1)

Type	Thread Code	Anvil Part Number	Punch Part Number
KFE/KFSE	440/116 -4 to -8	975200846300	975200048
KFE/KFSE	440/116 -10 to -12	975200847300	
KFE/KFSE	440/116 -16 to -20	975200848300	
KFE/KFSE	440/116 -20 to -24	975200882300	
KFE/KFSE	M3 -3 to -6	975200846300	
KFE/KFSE	M3 -8 to -10	975200847300	
KFE/KFSE	M3 -12 to -14	975201222300	
KFE/KFSE	M3 -14 to -16	975200848300	
KFE/KFSE	632/143 -4 to -8	975200849300	
KFE/KFSE	632/143 -10 to -12	975200850300	
KFE/KFSE	632/143 -16 to -20	975200851300	
KFE/KFSE	632/143 -22 to -24	975200883300	
KFE/KFSE	632/143 -28 to -32	975200884300	
KFE/KFSE	3.6 -3 to -6	975200849300	975200048
KFE/KFSE	3.6 -8 to -10	975200850300	
KFE/KFSE	3.6 -12 to -16	975200851300	
KFE/KFSE	4.2 -2	975201216300	
KFE/KFSE	4.2 -3 to -6	975201217300	
KFE/KFSE	4.2 -8 to -10	975201218300	
KFE/KFSE	4.2 -12 to -14	975201220300	
KFE/KFSE	4.2 -14 to -16	975201219300	

PEMSERTER® Installation Tooling (1)

Type	Thread Code	Anvil Part Number	Punch Part Number
PFK	440/M3	975200026	975200060
PFK	632	975200027	975200061

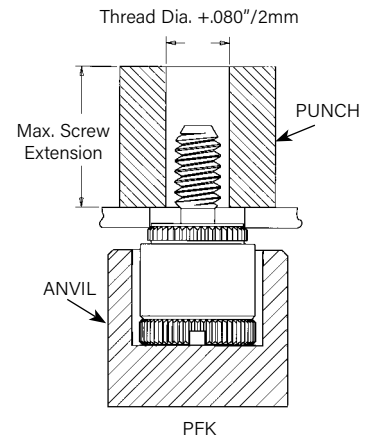

PEMSERTER® Installation Tooling (1)

Type	Thread Code	Anvil Part Number	Punch Part Number
KF2/KFS2	080	8015899	975200048
KF2/KFS2	256/440/M2/M2.5/M3	975200904300	
KF2/KFS2	632/M3.5	975200035	
KF2/KFS2	832/M4	975200037	
KF2/KFS2	032/M5	975200905300	

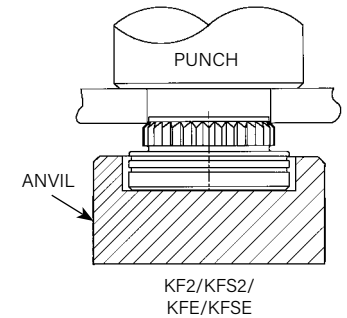

(1) [Click here](#) for a quote on Haeger® custom installation tooling.

KSSB™/KFH™ Fasteners

1. Prepare properly sized mounting hole in board.
2. Place fastener into mounting hole as shown.
3. With installation punch and anvil surfaces parallel, apply squeezing force until head contacts the board.

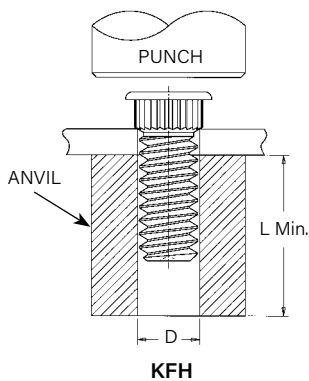

PEMSERTER® Installation Tooling (1)

Part Number	D +.003" -.000"	Punch Part No.	Anvil Part No.*
KFH-440-L	.113"	975200048	970200006300
KFH-632-L	.140"		970200007300
KFH-832-L	.166"		970200008300
KFH-032-L	.191"		970200009300

Part Number	D +0.08mm	Punch Part No.	Anvil Part No.*
KFH-M3-L	3.1mm	975200048	970200229300
KFH-M4-L	4.1mm		970200019300
KFH-M5-L	5.1mm		970200008300

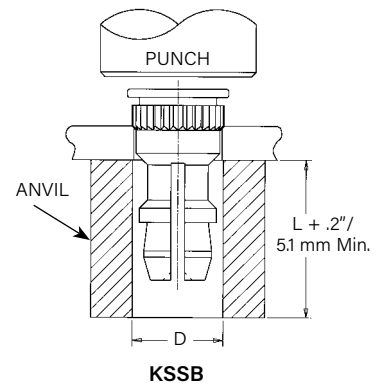

PEMSERTER® Installation Tooling (1)

Part Number	D +.003" -.000"/ +0.08mm	Punch Part No.	Anvil for material .050" / 1.27mm to .065" / 1.65mm	Anvil for material greater than .065" / 1.65mm
KSSB-156-L	.216"	975200048	8022167	970200015300
KSSB-4mm-L	5.49mm			

(1) [Click here](#) for a quote on Haeger® custom installation tooling.

For Additional HAEGER® and PEMSERTER® Tooling Information/Part Numbers visit our [tooling wizard](#)

KFB3™ Fasteners

1. Prepare properly sized mounting hole in board.
2. Place fastener into the anvil hole and place the mounting hole over the shank of the fastener as shown in diagram.
3. Using a punch flaring tool and a recessed anvil, apply squeezing force until the shoulder of the fastener contacts the board. As the fastener seats itself in the proper position, the punch tool will flare the extended portion of the shank outward to complete the installation. The combination of broaching and flaring provides high pushout performance.

PEMSERTER® Installation Tooling (1)

Thread Size	Length Code	Anvil	Punch (Flaring Tool)	
#4-40	-2	975201213300	975201231400	
#4-40	-4 to -8	975200846300		
#4-40	-10 to -12	975200847300		
#4-40	-16 to -20	975200848300		
#4-40	-20 to -24	975200882300		
#6-32	-2	975201215300	975201232400	
#6-32	-4 to -8	975200849300		
#6-32	-10 to -12	975200850300		
#6-32	-16 to -20	975200851300		
#6-32	-22 to -24	975200883300		
#6-32	-28 to -32	975200884300	8026680	
#10-32	-2	8026682		
#10-32	-4 to -8	8026683		
#10-32	-10 to -12	8026684		
#10-32	-16 to -20	8026685		
#10-32	-20 to -24	8026686		
#10-32	-28 to -32	8026687		
1/4-20	-2	8026688		8026681
1/4-20	-4 to -8	8026689		
1/4-20	-10 to -12	8026690		
1/4-20	-16 to -20	8026691		
1/4-20	-20 to -24	8026692		
1/4-20	-28 to -32	8026693		

Thread Size	Length Code	Anvil	Punch (Flaring Tool)
M3	-2	975201213300	975201231400
M3	-3 to -6	975200846300	
M3	-8 to -10	975200847300	
M3	-12 to -14	975201222300	
M3	-14 to -16	975200848300	
M4	-2	975201216300	975201221400
M4	-3 to -6	975201217300	
M4	-8 to -10	975201218300	
M4	-12 to -14	975201220300	
M4	-14 to -16	975201219300	
M5	-2	8026670	8026680
M5	-3 to -6	8026671	
M5	-8 to -10	8026672	
M5	-12 to -14	8026673	
M5	-14 to -16	8026674	
M6	-2	8026675	8026681
M6	-3 to -6	8026676	
M6	-8 to -10	8026677	
M6	-12 to -14	8026678	
M6	-14 to -16	8026679	

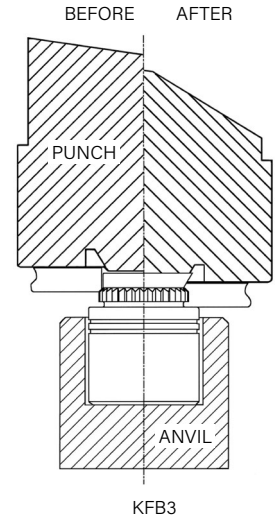

(1) PennEngineering manufactures and stocks the installation tooling for KFB3 fasteners.

[Click here](#) for a quote on Haeger® custom installation tooling.

SFK™ Fasteners

- Step 1. Prepare properly sized mounting hole in both panels.
- Step 2. Using only Panel 1, with the punch and anvil surfaces parallel, apply squeezing force until the fastener is flush with the top of Panel 1.
- Step 3. Place Panel 2 over fastener and apply squeezing force.

PEMSERTER® Installation Tooling (1)

Size	C ±0.13/±.003 (mm) / (.in.)	Punch Part No.	Anvil Part No.*
SFK-3	3.05 / .120	975200048	970200229300
SFK-5	5.05 / .199	975200048	970200020300

* Part number for anvil used in Step 2

NOTE: Fastener can be installed in both sheets at once when metal panel is adequately soft compared to the non-metal panel. E-mail techsupport@pemnet.com for more information.

(1) [Click here](#) for a quote on Haeger® custom installation tooling.

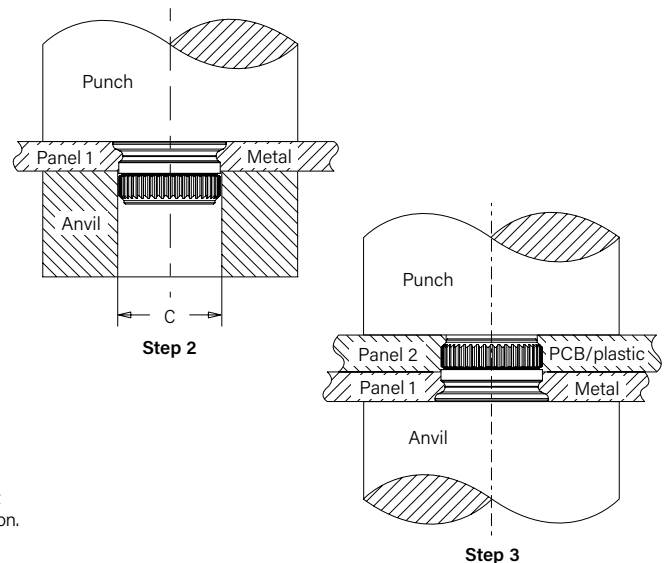

Installation Notes

- For best results we recommend using a HAEGER® or PEMSERTER® press for installation of PEM self-clinching fasteners. Please check our website for more information.
- Visit the Animation Library on our website to view the installation process [for select products](#).

Installation

SMTSO™ Nuts And Standoffs

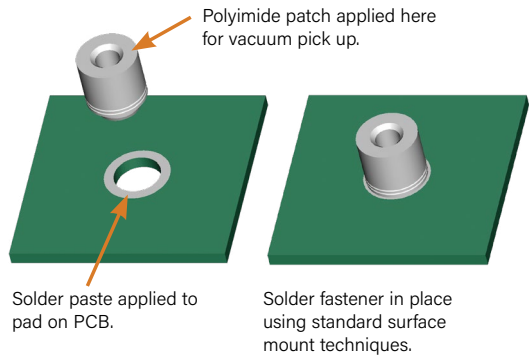

Smtra™ R'angle® Fasteners

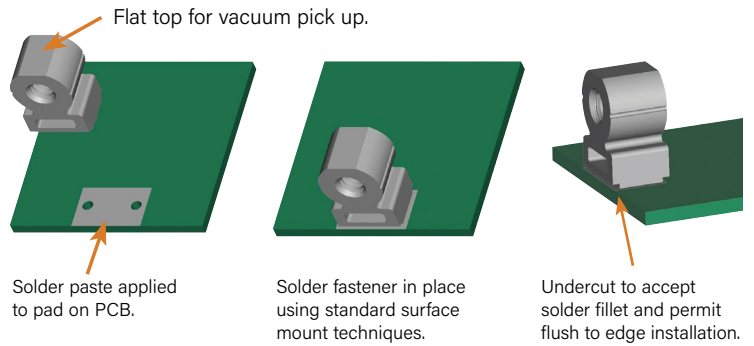

SMTPF™ Captive Panel Screws

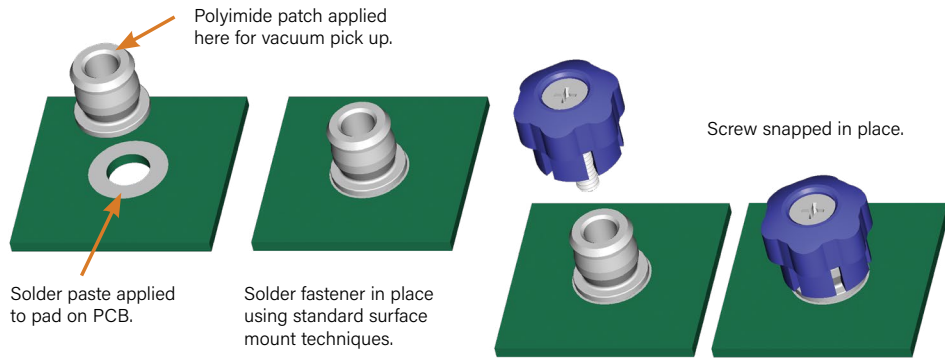

SMTBSO™ Fasteners

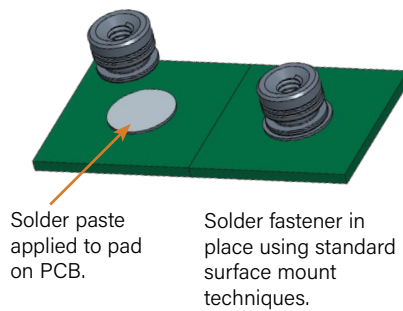

SMTPF LSM™ Captive Panel Screws

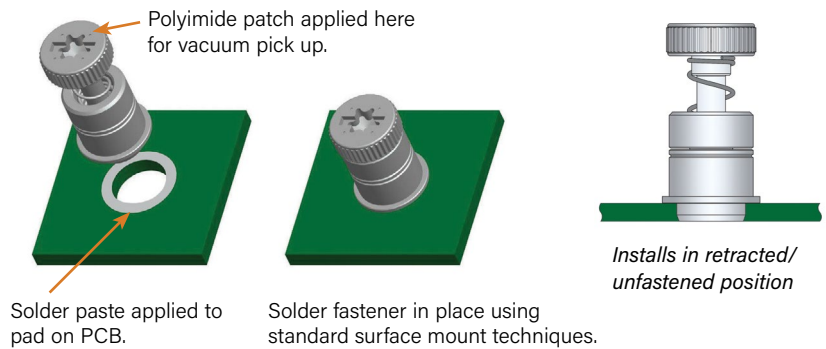

SMTSS™ Standoffs

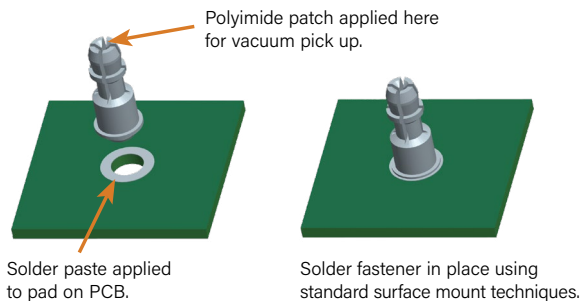

SMTSK™ Standoffs

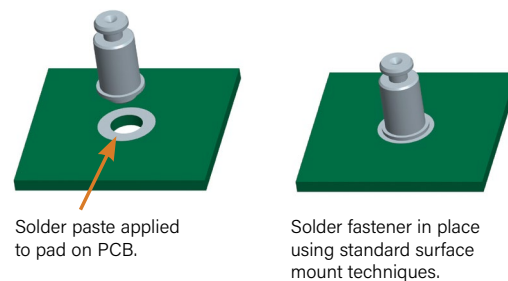

Performance Data⁽¹⁾

KF2™/KFS2™/KFE™/KFSE™/KFB3™/KFH™/PFK™ Broaching And Broach/Flare Mount Fasteners

Unified	Type	Thread Code	Max. Nut Tightening Torque (in. lbs.) ⁽²⁾	Test Sheet Thickness & Test Sheet Material	Installation (lbs.)	Pushout ⁽³⁾ (lbs.)	Torque-out (in. lbs.)	Rated Current Amps ⁽⁴⁾
	KF2, KFS2 KFE, KFSE	256	(5)	.060" FR-4 Panel	400	60	6	–
		440	(5)	.060" FR-4 Panel	400	65	15	–
		632	(5)	.060" FR-4 Panel	500	80	30	–
		832	(5)	.060" FR-4 Panel	700	95	35	–
		032	(5)	.060" FR-4 Panel	700	100	40	–
	KFB3	440	(5)	.060" FR-4 Panel	1000	140	18	42
		632	(5)	.060" FR-4 Panel	1500	170	28	88
		032	(5)	.060" FR-4 Panel	1600	180	30	100
		0420	(5)	.060" FR-4 Panel	1700	188	42	150
KFH	440	4	.060" FR-4 Panel	400	65	7	14	
	632	8	.060" FR-4 Panel	400	70	11	19	
	832	15	.060" FR-4 Panel	400	80	16	24	
	032	18	.060" FR-4 Panel	400	90	17	30	
PFK	440	(5)	.060" FR-4 Panel	250	55	(5)	–	
	632	(5)	.060" FR-4 Panel	400	60	(5)	–	

Metric	Type	Thread Code	Max. Nut Tightening Torque (N-m) ⁽²⁾	Test Sheet Thickness & Test Sheet Material	Installation (kN)	Pushout ⁽³⁾ (N)	Torque-out (N-m)	Rated Current Amps ⁽⁴⁾
	KF2, KFS2 KFE, KFSE	M2	(5)	1.5 mm FR-4 Panel	2.2	267	0.68	–
		M3	(5)	1.5 mm FR-4 Panel	2.2	290	1.7	–
		M4	(5)	1.5 mm FR-4 Panel	2.2	420	3.4	–
		M5	(5)	1.5 mm FR-4 Panel	2.9	440	4.5	–
	KFB3	M3	(5)	1.5 mm FR-4 Panel	4.4	560	2.03	42
		M4	(5)	1.5 mm FR-4 Panel	6	680	3.2	88
		M5	(5)	1.5 mm FR-4 Panel	7.1	800	3.5	100
		M6	(5)	1.5 mm FR-4 Panel	7.6	835	4.8	150
	KFH	M3	0.45	1.5 mm FR-4 Panel	1.8	285	0.79	15
M4		1.6	1.5 mm FR-4 Panel	1.8	355	1.8	23	
M5		2.1	1.5 mm FR-4 Panel	1.8	400	1.92	32	
PFK	M3	(5)	1.5 mm FR-4 Panel	1.1	245	(5)	–	

KSSB™ Broaching Snap-Top® Standoffs

Unified	Type	Panel 1 (.060" FR-4 Fiberglass) ⁽⁶⁾		Panel 2 (Removable) ⁽⁶⁾		
		Installation (lbs.)	Pushout (lbs.)	Max. First On Force (lbs.)	Min. First Off Force (lbs.)	Min. 15th Off Force (lbs.)
	KSSB	500	110	13	3.0	1.0

Metric	Type	Panel 1 (1.5 mm FR-4 Fiberglass) ⁽⁶⁾		Panel 2 (Removable) ⁽⁶⁾		
		Installation (kN)	Pushout (N)	Max. First On Force (N)	Min. First Off Force (N)	Min. 15th Off Force (N)
	KSSB	2.2	484	57.7	13.3	4.4

- (1) Published installation forces are for general reference. Actual set-up and confirmation of complete installation should be made by observing proper seating of fastener as described in the installation steps. Other performance values reported are averages when all proper installation parameters and procedures are followed. Variations in mounting hole size, sheet material, and installation procedure may affect performance. Performance testing this product in your application is recommended. We will be happy to provide technical assistance and/or samples for this purpose.
- (2) Torque values shown will produce a preload of 70% minimum tensile with a nut factor "k" equal to 1.
- (3) These are typical values for parts installed in drilled mounting holes. Punched mounting holes yield values approximately 15% less.
- (4) The maximum carrying current for each of the above fasteners is calculated based on a heat transfer coefficient of 20 W/m² °K and a maximum temperature rise of 15°C / 27°F above ambient.
- (5) Not applicable.
- (6) See Application Data drawing on page 11.

SFK™ SpotFast® Clinch/Broach Mount Fasteners

Type and Size	Thick-ness Code	Installation into Panel 1		Installation into Panel 2		Pushout of Panel 2 (3)	
		Cold-rolled Steel		FR-4 Fiberglass		N lbs.	
		kN	lbs.	kN	lbs.		
SFK-3	0.8	6.2	1400	1.8	400	200	45
SFK-3	1.0	8	1800	1.8	400	200	45
SFK-3	1.2	8.9	2000	1.8	400	200	45
SFK-3	1.6	10.2	2300	1.8	400	200	45
SFK-5	0.8	11.1	2500	1.8	400	400	90
SFK-5	1.0	13.5	3000	1.8	400	400	90
SFK-5	1.2	15.6	3500	1.8	400	400	90
SFK-5	1.6	17.8	4000	1.8	400	400	90

SMTSS™ ReelFast® SNAP-TOP® Standoffs(1)(2)

Type, Material and Size	Panel 1 (Bottom)		Panel 2 (Top)
	Test Sheet Material	Pushout	Max. Snap-on Force
	SMTSS-156	.062" Single Layer FR-4	113 lbs.
SMTSS-4MM	1.58 mm Single Layer FR-4	500 N	89 N

SMTSK™ Keyhole® Standoffs(1)(2)

Type and Size	Panel 1 (Bottom)	
	Test Sheet Material	Pushout
	SMTSK-6060	.062" Single Layer FR-4
SMTSK-61.5	1.58 mm Single Layer FR-4	500 N

SMTSO™/SMTSOB™ Fasteners(1)(2)

Type	Thread/ Thru-hole Code	Test Sheet Material - .062" Single Layer FR-4				Rated Current Amps (4)
		Pushout (lbs.)	Pushout (N)	Torque-out (in. lbs.)	Torque-out (N-m)	
SMTSO	080	85.1	378.7	4.94	0.56	11
SMTSOB						—
SMTSO	256	56.5	251	8.56	1	25
SMTSOB						40
SMTSO	440	56.5	251	8.56	1	22
SMTSOB						36
SMTSO	632	93.5	416	13.83	1.6	34
SMTSOB						55
SMTSO	832	151.1	672	26.96	3	47
SMTSOB						76
SMTSO	116	—	—	—	—	22
SMTSOB						37
SMTSO	143	—	—	—	—	33
SMTSOB						55
SMTSO	M1	85.1	378.7	4.94	0.56	11
SMTSOB						—
SMTSO	M1.2	85.1	378.7	4.94	0.56	10
SMTSOB						—
SMTSO	M1.4	85.1	378.7	4.94	0.56	10
SMTSOB						—
SMTSO	M1.6	85.1	378.7	4.94	0.56	10
SMTSOB						—
SMTSO	M3	56.5	251	8.56	1	22
SMTSOB						36
SMTSO	M3.5	93.5	416	13.83	1.6	34
SMTSOB						55
SMTSO	M4	151.1	672	26.96	3	47
SMTSOB						76
SMTSO	3.1	—	—	—	—	22
SMTSOB						36
SMTSO	3.6	—	—	—	—	33
SMTSOB						55
SMTSO	4.2	—	—	—	—	46
SMTSOB						75

SMTRA™ R'ANGLE® Fasteners(1)(2)

Unified	Part Number	Test Sheet Material - .062" Single Layer FR-4	
		Pushout (lbs.)	Side Load (lbs.)
	SMTRA256-8-6	51.7	71
SMTRA440-9-6	89.5	10.8	
SMTRA632-10-8	110.3	8.4	
SMTRA832-12-9	1372	21.2	

Metric	Part Number	Test Sheet Material - 1.58 mm Single Layer FR-4	
		Pushout (N)	Side Load (N)
	SMTRAM2-6-5	418.2	56.8
SMTRAM25-6-5	216.5	36.9	
SMTRAM3-7-5	257.6	41.3	
SMTRAM4-9-7	369.3	73.3	

SMTBSO™ Fasteners(1)

Part Number	Test Sheet Material - .062"/1.58mm Single Layer FR-4				Rated Current Amps (4)
	Pull Off (lbs.)	Pull Off (N)	Torque-out (in. lbs.)	Torque-out (N-m)	
SMTBSO-440-6	61	—	15.4	—	12
SMTBSO-M3-4	—	270	—	1.75	22

Testing Conditions For Surface Mounted Fasteners

Oven	Quad ZCR convection oven w/ 4 zones	Spokes	2 Spoke Pattern
High Temp	473°F / 245°C	Paste	Amtech NC559LF Sn96.5/3.0Ag/0.5Cu (SAC305) (SMTSO, SMTRA, SMTPR)
Board Finish	62% Sn, 38% Pb		Alpha CVP-390 Sn96.5/3.0Ag/0.5Cu (SAC305) (SMTPLSM, SMTSS, SMTSK, SMTBSO)
Screen Printer	Ragin Manual Printer	Stencil	.0067" / 0.17 mm thick (SMTSO, SMTRA, SMTPR, SMTSS, SMTSK, SMTBSO)
Vias	None		.005" / 0.13 mm thick (SMTPLSM)

- (1) With lead-free paste. Average values of 30 test points. The data presented here is for general comparison purposes only. Actual performance is dependent upon application variables. We will be happy to provide samples for you to install. If required, we can also test your installed hardware and provide you with the performance data specific to your application.
- (2) Further testing details can be found in our website's literature section.
- (3) In most applications, pullout strength of the SFK fastener in Panel 1 exceeds pushout strength of Panel 2.
- (4) The maximum carrying current for each of the above fasteners is calculated based on a heat transfer coefficient of 20 W/m² °K and a maximum temperature rise of 15°C / 27°F above ambient.

SMTPFSLM™ Fasteners⁽¹⁾

Unified	Type and Thread Size	Min. Tensile Strength (lbs.)	Rec. Tightening Torque (in. lbs.) (2)	Test Sheet Material	
				.060" P.C. Board	
				Pull-off (lbs.) (3)	
	SMTPFSLM-440	556	4.4	100	
	SMTPFSLM-632	724	7.0	105	

Metric	Type and Thread Size	Min. Tensile Strength (N)	Rec. Tightening Torque (N-m) (2)	Test Sheet Material	
				1.5 mm P.C. Board	
				Pull-off (N) (3)	
	SMTPFSLM-M3	2900	0.61	445	
	SMTPFSLM-M3.5	3269	0.8	465	

SMTPR™ Retainers⁽¹⁾

Part Number	Test Sheet Material - .062" Single Layer FR-4	
	Pushout (lbs.)	Pushout (N)
SMTPR-6-1ET	161.4	718

Testing Conditions For Surface Mounted Fasteners

- Oven** Quad ZCR convection oven w/ 4 zones
- High Temp** 473°F / 245°C
- Board Finish** 62% Sn, 38% Pb
- Screen Printer** Ragin Manual Printer
- Vias** None
- Spokes** 2 Spoke Pattern
- Paste** Amtech NC559LF Sn96.5/3.0Ag/0.5Cu (SAC305) (SMTSO, SMTRA, SMTPR)
Alpha CVP-390 Sn96.5/3.0Ag/0.5Cu (SAC305) (SMTPFSLM, SMTSS, SMTSK)
- Stencil** .0067" / 0.17 mm thick (SMTSO, SMTRA, SMTPR, SMTSS, SMTSK)
.005" / 0.13 mm thick (SMTPFSLM)

- (1) With lead-free paste. Average values of 30 test points. The data presented here is for general comparison purposes only. Actual performance is dependent upon application variables. We will be happy to provide samples for you to install. If required, we can also test your installed hardware and provide you with the performance data specific to your application.
- (2) Torque values shown will produce a preload of 70% minimum tensile with a nut factor "k" equal to .1.
- (3) Failure occurred at the solder joint. Screw retention strength is greater than the retainer.

SMTSO™ Reflow Curve

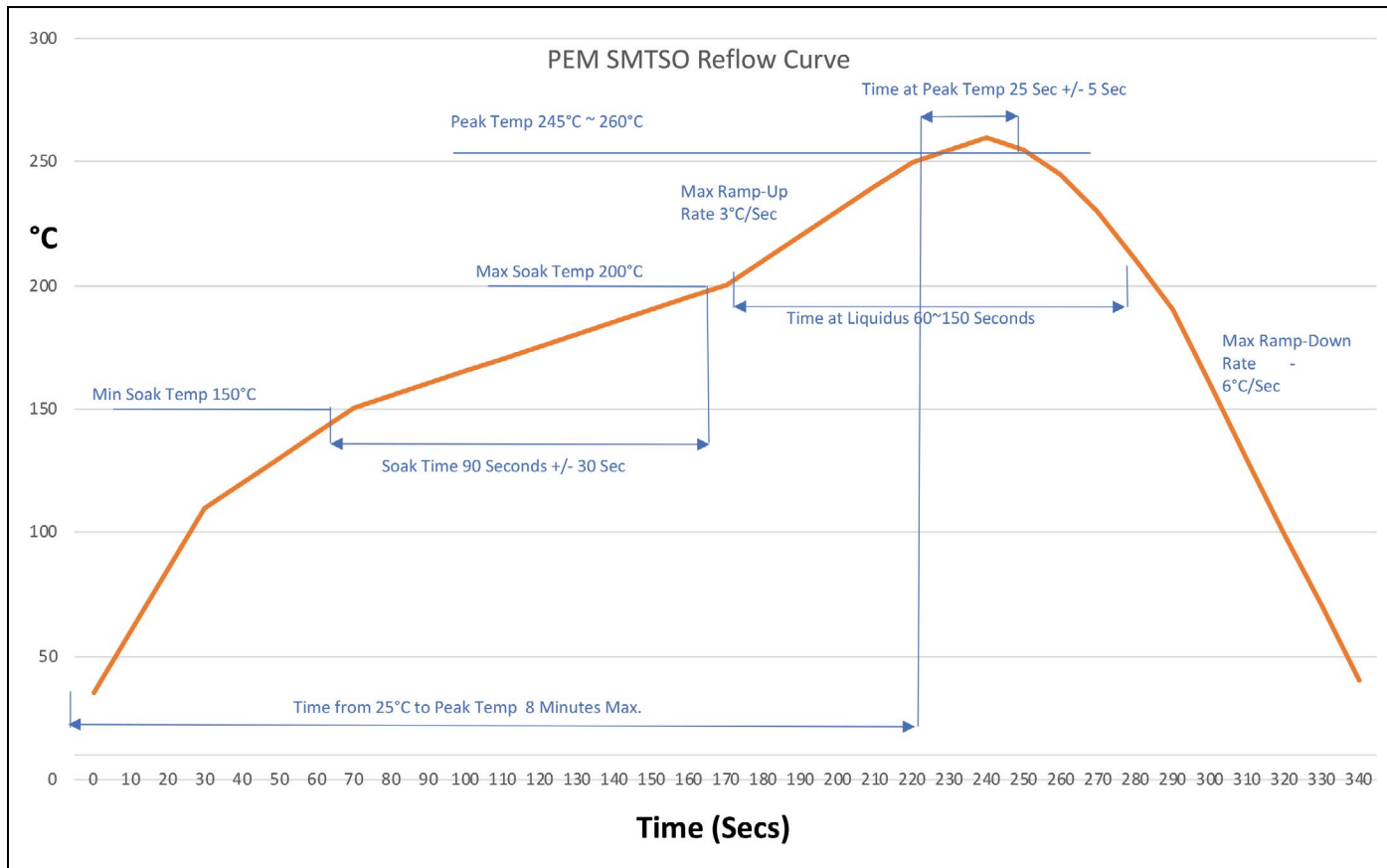

Other Fasteners For Consideration To Use With PC Boards

PF11MW™ Floating Captive Panel Screws

(See PEM® Bulletin PF)

Unique flare mount feature allow fasteners to “float” in mounting hole.

- Compensates for mating thread misalignment.
- Installs into any panel material.
- Appropriate for close center-line-to-edge applications.
- Color coded knobs available.



PF11MF™ Flare-Mounted Captive Panel Screws

(See PEM® Bulletin PF)

- Appropriate for close centerline-to-edge applications.
- Doesn't require high installation force.
- Installs into any panel material.
- Installs flush on back side of panel.
- Color coded knobs available.

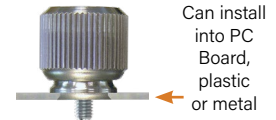

SGPC™ Swaging Collar Studs

(See PEM® Bulletin FH)

- Can be installed into most materials, including stainless steel and rigid non-metallic panels.
- Can be used to attach dissimilar materials.
- Can accommodate multiple panels as long as the total thickness does not exceed the maximum sheet thickness.
- Appropriate for close center-line-to-edge applications.

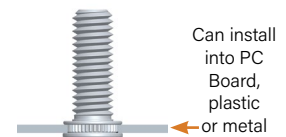

SOAG™/SOSG™ Grounding Standoffs

(See PEM® Bulletin SO)

- Designed for clinching into steel or aluminum chassis.
- “Gripping teeth” on opposite side of standoff makes firm electrical contact with mating PC Board.

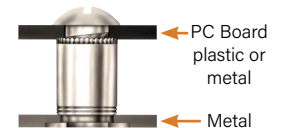

SKC™ Keyhole® Standoffs

(See PEM® Bulletin SK)

- Clinch feature mounts fastener permanently into metal sheet.
- Allows for quick attachment and detachment of PC Board.
- Head is flush or sub-flush in metal sheet.
- Makes horizontal or vertical component mounting possible.



SSA™/SSC™/SSS™ Snap-Top® Standoffs

(See PEM® Bulletin SSA)

- Spring action holds PC Boards and subassemblies securely, while allowing for quick removal.
- Screws and other threaded hardware are eliminated.

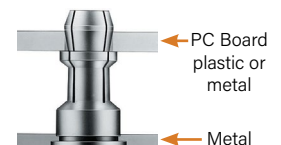

For more information on these and other PEM products, visit our PEMNET™ Resource Center at www.pemnet.com

All PEM® products meet our stringent quality standards. If you require additional industry or other specific [quality certifications](#), special procedures and/or part numbers are required. Please contact your local sales office or representative for further information.

Regulatory [compliance information](#) is available in Technical Support section of our website. Specifications subject to change without notice. See our website for the most current version of this bulletin.



North America: Danboro, Pennsylvania USA | E-mail: info@pemnet.com | Tel: +1-215-766-8853 | 800-237-4736 (USA)

Europe: Galway, Ireland | E-mail: europa@pemnet.com | Tel: +353-91-751714

Asia/Pacific: Singapore | E-mail: singapore@pemnet.com | Tel: +65-6-745-0660

Kunshan, China: E-mail: salesgreaterchina@pemnet.com | Tel: +86-512-5276-9300

Visit our PEMNET™ Resource Center at www.pemnet.com • Technical support e-mail: techsupport@pemnet.com