

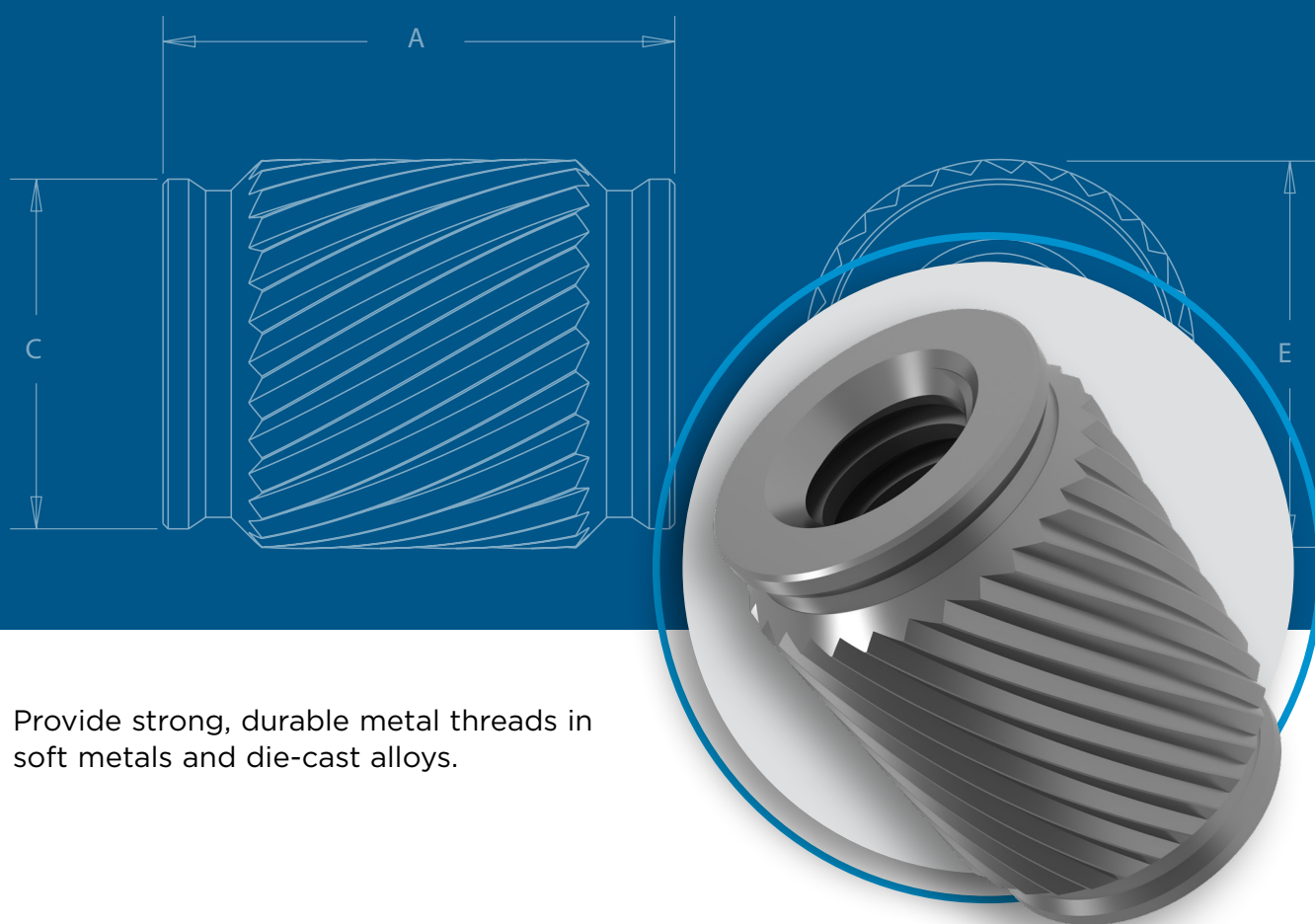

CK™

CASTSERT® PRESS-IN INSERTS FOR CASTINGS AND SOFT METALS



Provide strong, durable metal threads in soft metals and die-cast alloys.

PEM® CASTSERT® PRESS-IN INSERTS

For Castings and Soft Metals HRB 70 / HB 125 or less

PEM® 300 Series Stainless Steel CASTSERT® inserts provide strong, durable metal threads in soft metals and die-cast alloys. The simple press-in and rapid installation process for these inserts uses a flat punch and anvil to install all sizes and lengths, approximately 80% faster than other methods.

- Designed for flush installation with flat punch and anvil into blind holes or thru-holes
- Process cost savings vs. coil inserts or thread tapping
- Installed into drilled holes or as-cast holes with low draft angle
- Pilot for rapid seating and self-alignment
- Symmetric for auto-feed capability



Patent Pending

Fastener drawings and models are available at www.pemnet.com. Custom sizes are available on special order. [Contact us](#) for more information.

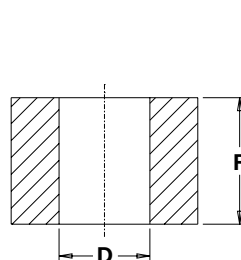
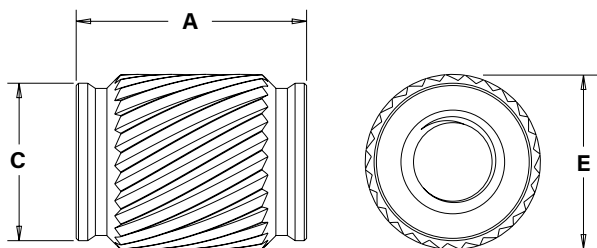

Straight Hole

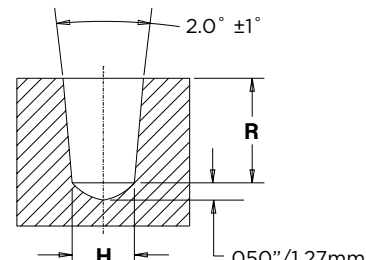

Tapered Hole

All dimensions are in inches.

Unified	Thread Size	Type	Thread Code	Length Code	Length A ±.005	After Knurl E Nom.	Pilot C Max.	Min. Sheet Thickness R	Hole Size in Material ⁽¹⁾		
		Stainless Steel							Straight Hole Dia. D +.003 -.000	Min. Dia. H of Tapered Hole ⁽²⁾ at Length R	Min. Dist. Hole C/L to Edge ⁽³⁾
	.086-56 (#2-56)	CKS	256	1	.125	.196	.179	.130	.188	.180	.151
				2							
				1							
				2							
				1							
				2							
				1							
				2							
				1							
				2							

All dimensions are in millimeters.

Metric	Thread Size x Pitch	Type	Thread Code	Length Code	Length A ±0.13	After Knurl E Nom.	Pilot C Max.	Min. Sheet Thickness R	Hole Size in Material ⁽¹⁾		
		Stainless Steel							Straight Hole Dia. D +0.08	Min. Dia. H of Tapered Hole ⁽²⁾ at Length R	Min. Dist. Hole C/L to Edge ⁽³⁾
		M2.5 x 0.45	CKS	M2.5	1	3.18	4.98	4.55	3.3	4.76	4.57
	M3 x 0.5	CKS	M3	1	4.45	5.79	5.31	4.57	5.56	5.33	4.44
	M4 x 0.7	CKS	M4	1	6.35	7.49	6.76	6.48	7.15	6.78	5.72
	M5 x 0.8	CKS	M5	1	7.62	9.09	8.37	7.75	8.73	8.38	6.92
	M6 x 1	CKS	M6	1	9.53	11.48	10.74	9.65	11.11	10.77	8.71
				2	15.88			16			

- 1) Blind holes to include .050"/1.27mm min. of hole clearance for material build up during install.
- 2) Draft hole performance will vary greatly depending on length of engagement of the knurl over the installed length. For best results, recommend use of 3 degree or less total draft and design hole as close to H as possible at depth R to optimize length and depth of knurl engagement.
- 3) Centerline to edge constraints are highly dependent on panel material and may have different failure modes depending on panel ductility. It is highly recommended to test for center-line to edge constraints in your specific application.

Part Number Designation

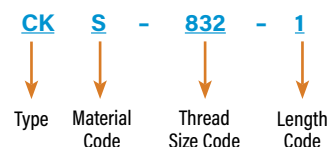

Custom sizes are available on special order. [Contact us](#) for more information.

Material and Finish Specifications

	Threads	Fastener Material	Standard Finish	For Use in Castings and Soft Metals: (1)
Type	Internal, ASME B1.1, 2B / ASME B1.13M, 6H	300 Series Stainless Steel	Passivated and/or Tested per ASTM A380	HRB 70 / HB 125 or less
CKS
Part Number Code for Finishes			None	

(1) HRB - Hardness Rockwell "B" Scale. HB - Hardness Brinell.

Installation

For best results we recommend using a HAEGER® machine with custom tooling to install PEM® CastSert® inserts. For a quote, please visit www.haeger.com/customtooling or email us at customtooling@haeger.com.



For Additional HAEGER®
and PEMSERTER® Tooling
Information/Part Numbers
visit our [tooling wizard](#)



Performance Data⁽¹⁾

Unified	Thread Code	Length Code	Test Sheet Material		
			ADC12 Die Cast Aluminum (A383 Equivalent)		
			Installation (lbs.)	Pullout (lbs.)	Torque-out (in. lbs.)
256	1	1	920	65	19
		2	1415	135	
440	1	1	1100	75	36
		2	1615	145	
632	1	1	1700	180	54
		2	2200	280	
832	1	1	1820	220	74
		2	3415	530	
032	1	1	2810	250	144
		2	4114	670	
0420	1	1	5010	570	273
		2	6710	1345	

Metric	Thread Code	Length Code	Test Sheet Material		
			ADC12 Die Cast Aluminum (A383 Equivalent)		
			Installation (kN)	Pullout (N)	Torque-out (N-m)
M2.5	1	1	4.1	300	2.2
		2	6.3	600	
M3	1	1	4.9	340	4.1
		2	7.2	660	
M4	1	1	8.1	800	8.4
		2	15.2	2100	
M5	1	1	12.5	1120	16.3
		2	18.3	3000	
M6	1	1	22.3	2550	30.8
		2	30.3	6000	

(1) Published installation forces are for general reference. Actual set-up and confirmation of complete installation should be made by observing proper seating of fastener as described in the installation steps. Installation force and torque-out values reported are averages when all proper installation parameters and procedures are followed. Variations in mounting hole size, sheet material, and installation procedure may affect performance. Performance testing this product in your application is recommended. We will be happy to provide technical assistance and/or samples for this purpose.

Notes:

- Performance data in drilled straight hole condition with recommended hole tolerances in JIS H 5302 Grade ADC12 Die-cast Aluminum.
- ADC12 material hardness recorded at Hardness 70 HB (Hardness Brinell 70).
- Performance data collected from a sample size of 28 pieces from production lot.
- Grade 12.9 Socket Head Cap Screws failed in Torque for all samples. Torque-out data shown is average bolt breakage.
- Pullout data varies greatly part to part as common with cast metals. Published data is the minimum force to pull insert out of sheet in the 28 piece sample.

To prevent jack-out, it is very important that the clearance hole of the mating component is sized correctly. The clearance hole should be larger than the assembly screw, yet smaller than the outside diameter of the insert so that the insert, not the host panel, carries the compressive load. CASTSERT® inserts can also jack-out when mating hardware bottoms out in a blind application. To ensure bottoming out does not occur, the proper length of mating hardware must be selected.

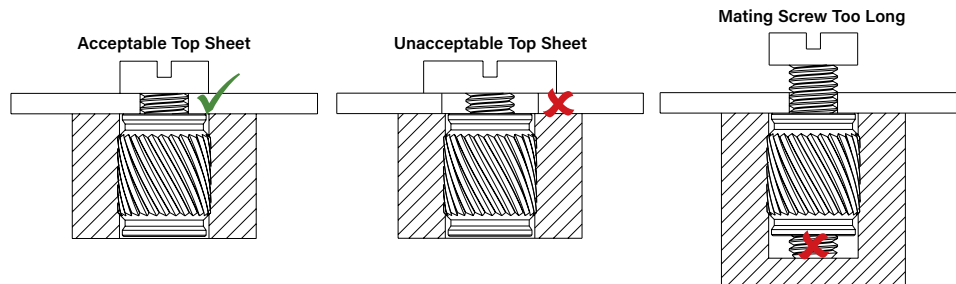

All pullout tests were conducted as shown in the diagram labeled "normal mating configuration". If possible in application, mating from the side opposite of installation such as shown in the "optimal mating configuration" will increase pullout performance. For additional pull-out performance in thru-hole applications, loading the joint opposite the side of installation would essentially provide pull-out equal to the installation force.

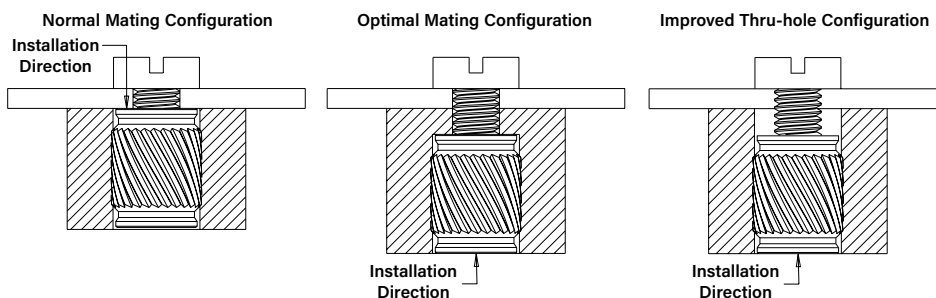

All PEM® products meet our stringent quality standards. If you require additional industry or other specific [quality certifications](#), special procedures and/or part numbers are required. Please contact your local sales office or representative for further information.

Regulatory [compliance information](#) is available in Technical Support section of our website. Specifications subject to change without notice. See our website for the most current version of this bulletin.



North America: Danboro, Pennsylvania USA | E-mail: info@pemnet.com | Tel: +1-215-766-8853 | 800-237-4736 (USA)
Europe: Galway, Ireland | E-mail: europa@pemnet.com | Tel: +353-91-751714
Asia/Pacific: Singapore | E-mail: singapore@pemnet.com | Tel: +65-6-745-0660
Kunshan, China: E-mail: salesgreaterchina@pemnet.com | Tel: +86-512-5726-9300
 Visit our PEMNET™ Resource Center at www.pemnet.com • Technical support e-mail: techsupport@pemnet.com